

# **PRODUCTION TECHNOLOGY**

## Metal Casting Process

### Manufacturing

- Manufacturing in its broadest sense is the process of converting raw materials into useful products.
- It includes
  - i) Design of the product
  - ii) Selection of raw materials and
  - iii) The sequence of processes through which the product will be manufactured.

### Casting

Casting is the process of producing metal parts by pouring molten metal into the mould cavity of the required shape and allowing the metal to solidify. The solidified metal piece is called as “casting”.

### Types of casting

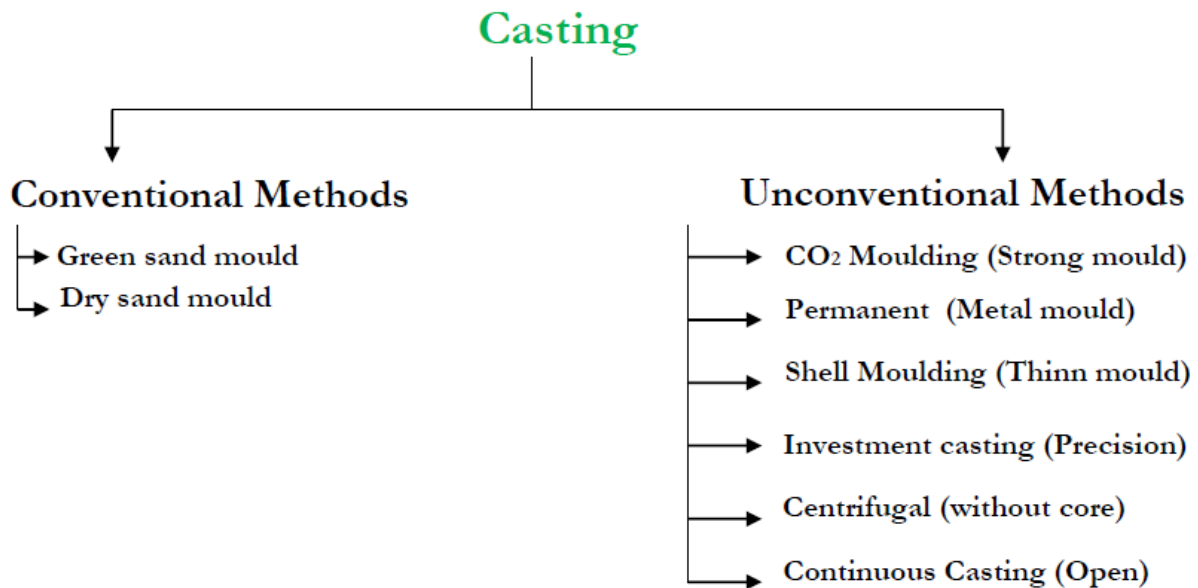

### Advantages

- Design flexibility
- Reduced costs
- Dimensional accuracy
- Versatility in production

### Disadvantages

- Lot of molten metal is wasted in riser & gating
- Casting may require machining to remove rough surfaces

Sand Casting is simply melting the metal and pouring it into a preformed cavity, called mold, allowing (the metal to solidify and then breaking up the mold to remove casting. In sand casting expandable molds are used. So for each casting operation you have to form a new mold.

- Most widely used casting process.
- Parts ranging in size from small to very large
- Production quantities from one to millions
- Sand mold is used.
- Patterns and Cores
  - Solid, Split, Match-plate and Cope-and-drag Patterns
  - Cores – achieve the internal surface of the part

### Molds

- Sand with a mixture of water and bonding clay
- Typical mix: 90% sand, 3% water, and 7% clay
- to enhance strength and/or permeability

Sand – Refractory for high temperature

### Size and shape of sand

Small grain size -> better surface finish

Large grain size -> to allow escape of gases during pouring

Irregular grain shapes -> strengthen molds due to interlocking but to reduce permeability

### Types of sand

- a) Green-sand molds - mixture of sand, clay, and water; "Green" means mold contains moisture at time of pouring.
- b) Dry-sand mold - organic binders rather than clay and mold is baked to improve strength
- c) Skin-dried mold - drying mold cavity surface of a green-sand
  - mold to a depth of 10 to 25 mm, using torches or heating

### Steps in Sand Casting

The cavity in the sand mold is formed by packing sand around a pattern, separating the mold into two halves

- The mold must also contain gating and riser system
  - For internal cavity, a core must be included in mold
  - A new sand mold must be made for each part
1. Pour molten metal into sand mold
  2. Allow metal to solidify
  3. Break up the mold to remove casting
  4. Clean and inspect casting
  5. Heat treatment of casting is sometimes required to improve metallurgical properties

### Testing of Mould & Core sand

- 1) Preparation of standard test specimen
- 2) Mould hardness test
- 3) Core hardness test
- 4) Moisture content test on foundry sand
- 5) Sieve analysis
- 6) Clay content test
- 7) Permeability test
- 8) Compression, shear test

### Other Expendable Mold Casting

- Shell Molding
- Vacuum Molding
- Expanded Polystyrene Process
- Investment casting
- Plaster and Ceramic Mold casting

### Steps in shell-molding

Shell-mold casting yields better surface quality and tolerances. The process is described as follows:

The 2-piece pattern is made of metal (e.g. aluminum or steel), it is heated to between 175°C- 370°C, and coated with a lubricant, e.g. silicone spray.

Each heated half-pattern is covered with a mixture of sand and a thermoset resin/epoxy binder.

The binder glues a layer of sand to the pattern, forming a shell. The process may be repeated to get a thicker shell.

The assembly is baked to cure it.

The patterns are removed, and the two half-shells joined together to form the mold; metal is poured into the mold.

When the metal solidifies, the shell is broken to get the part.

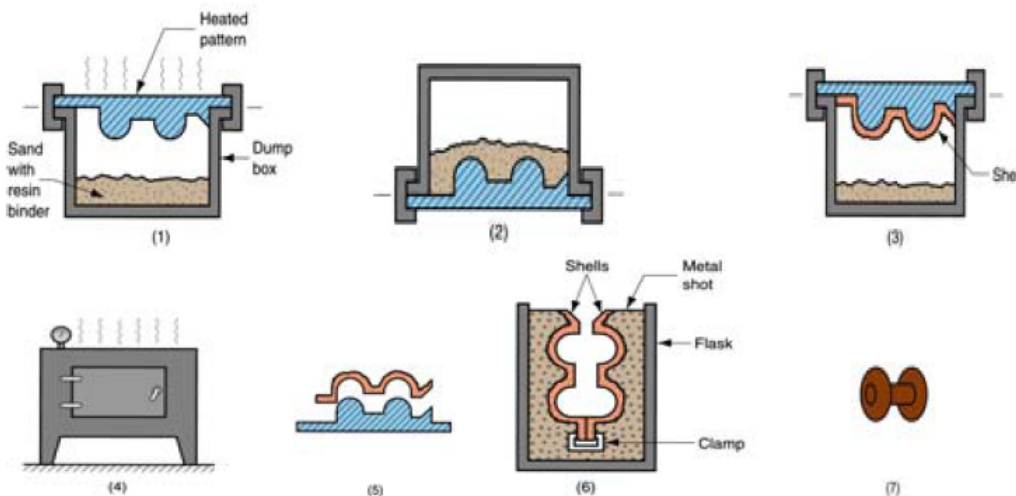

## Advantages

- Smoother cavity surface permits easier flow of molten metal and better surface finish on casting
- Good dimensional accuracy
- Machining often not required
- Mold collapsibility usually avoids cracks in casting
- Can be mechanized for mass production

## Disadvantages

- More expensive metal pattern
- Difficult to justify for small quantities

## Investment Casting

- Investment casting produces very high surface quality and dimensional accuracy.
- Investment casting is commonly used for precision equipment such as surgical equipment, for complex geometries and for precious metals.
- This process is commonly used by artisans to produce highly detailed artwork.
- The first step is to produce a pattern or replica of the finished mould. Wax is most commonly used to form the pattern, although plastic is also used.
- Patterns are typically mass-produced by injecting liquid or semi-liquid wax into a permanent die.
- Prototypes, small production runs and specialty projects can also be undertaken by carving wax models.
- Cores are typically unnecessary but can be used for complex internal structures. Rapid prototyping techniques have been developed to produce expendable patterns.
- Several replicas are often attached to a gating system constructed of the same material to form a tree assembly. In this way multiple castings can be produced in a single pouring.

## Casting with expendable mould: Investment Casting

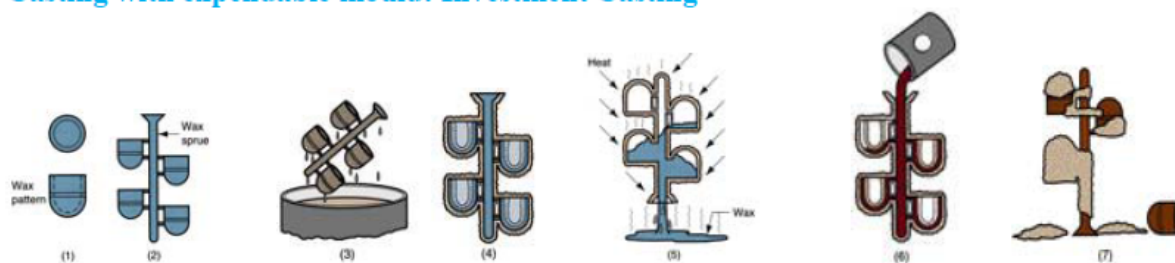

## Advantages

- Parts of great complexity and intricacy can be cast
- Close dimensional control and good surface finish
- Wax can usually be recovered for reuse
- Additional machining is not normally required - this is a net shape process

## Disadvantages

- Many processing steps are required
  - Relatively expensive process
-

### Plaster Molding

- Similar to sand casting except mold is made of plaster of Paris (gypsum -  $\text{CaSO}_4 \cdot 2\text{H}_2\text{O}$ )
- Plaster and water mixture is poured over plastic or metal pattern to make a mold

### Advantages

- Good dimensional accuracy and surface finish
- Capability to make thin cross-sections in casting

### Disadvantages

- Moisture in plaster mold causes problems:
- Mold must be baked to remove moisture
- Mold strength is lost when is over-baked, yet moisture content can cause defects in product
- Plaster molds cannot stand high temperatures

### Permanent Mold Casting

#### Basic Permanent Mold Process

- Uses a metal mold constructed of two sections designed for easy, precise opening and closing
- Molds for lower melting point alloys: steel or cast iron and Molds for steel: refractory material, due to the very high pouring temperatures

### Permanent Mold Casting Process

- The two halves of the mold are made of metal, usually cast iron, steel, or refractory alloys. The cavity, including the runners and gating system are machined into the mold halves.
- For hollow parts, either permanent cores (made of metal) or sand-bonded ones may be used, depending on whether the core can be extracted from the part without damage after casting.
- The surface of the mold is coated with clay or other hard refractory material – this improves the life of the mold. Before molding, the surface is covered with a spray of graphite or silica, which acts as a lubricant. This has two purposes – it improves the flow of the liquid metal, and it allows the cast part to be withdrawn from the mold more easily.
- The process can be automated, and therefore yields high throughput rates.
- It produces very good tolerance and surface finish.
- It is commonly used for producing pistons used in car engines; gear blanks, cylinder heads, and other parts made of low melting point metals, e.g. copper, bronze, aluminum, magnesium, etc.

### Advantage

- Good surface finish and dimensional control and Fine grain due to rapid solidification.

### Disadvantage

- Simple geometric part, expensive mold.

### Example

It is commonly used for producing pistons used in car engines; gear blanks, cylinder heads, and other parts made of low melting point metals, e.g. copper, bronze, aluminum, magnesium, etc.

## Basic Permanent Mold Process

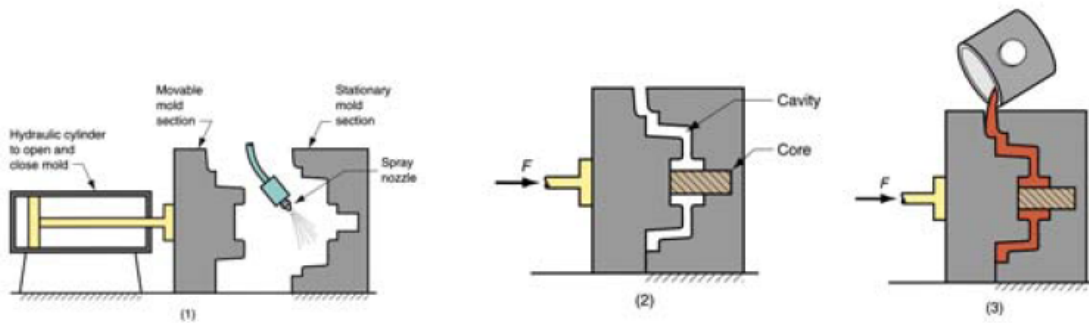

### Advantages

- Good dimensional control and surface finish
- More rapid solidification caused by the cold metal mold results in a finer grain structure, so stronger castings are produced

### Limitations

- Generally limited to metals of lower melting point
- Simple part geometries compared to sand casting because of the need to open the mold
- High cost of mold
- Due to high mold cost, process is best suited to automated high volume production

### Testing of Mould & Core sand

- 1) Preparation of standard test specimen
- 2) Mould hardness test
- 3) Core hardness test
- 4) Moisture content test on foundry sand
- 5) Sieve analysis
- 6) Clay content test
- 7) Permeability test
- 8) Compression, shear test

### Die Casting

- Die casting is a very commonly used type of permanent mold casting process.
  - It is used for producing many components of home appliances (e.g rice cookers, stoves, fans, washing and drying machines, fridges), motors, toys and hand-tools
  - The molten metal is injected into mold cavity (die) under high pressure (7-350MPa). Pressure maintained during solidification.
  - Hot Chamber (Pressure of 7 to 35MPa)
  - The injection system is submerged under the molten metals (low melting point metals such as lead, zinc, tin and magnesium)
  - Cold Chamber (Pressure of 14 to 140MPa)
  - External melting container (in addition aluminum, brass and magnesium)
- Molds are made of tool steel, mold steel, maraging steel, tungsten and molybdenum.
- Single or multiple cavity
  - Lubricants and Ejector pins to free the parts

- Venting holes and passageways in die
- Formation of flash that needs to be trimmed

### Properties of die-casting

- 1) Huge numbers of small, light castings can be produced with great accuracy.
- 2) Little surface finishing is required.
- 3) Permanent mold (dies can be used over and over)

### Advantages

– High production, Economical, close tolerance, good surface finish, thin sections, rapid cooling

### Hot-Chamber Die Casting

In a hot chamber process (used for Zinc alloys, magnesium) the pressure chamber connected to the die cavity is filled permanently in the molten metal.

The basic cycle of operation is as follows:

- (i) die is closed and gooseneck cylinder is filled with molten metal;
- (ii) plunger pushes molten metal through gooseneck passage and nozzle and into the die cavity; metal is held under pressure until it solidifies;
- (iii) die opens and cores, if any, are retracted; casting stays in ejector die; plunger returns, pulling molten metal back through nozzle and gooseneck;
- (iv) ejector pins push casting out of ejector die. As plunger uncovers inlet hole, molten metal refills gooseneck cylinder.

The hot chamber process is used for metals that (a) have low melting points and (b) do not alloy with the die material, steel; common examples are tin, zinc, and lead.

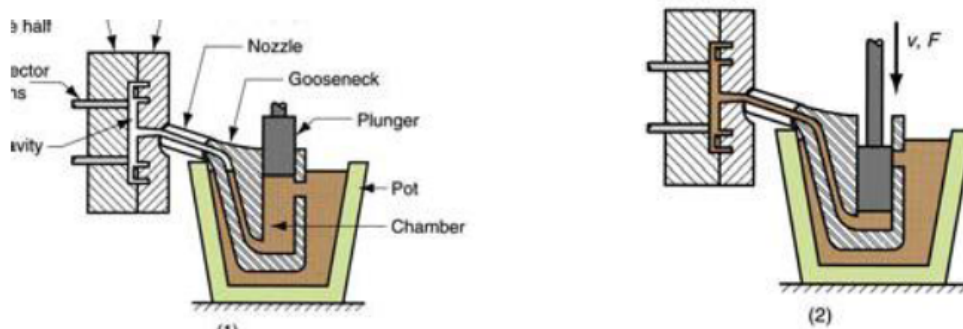

### Cold Chamber Die Casting

In a cold chamber process, the molten metal is poured into the cold chamber in each cycle. The operating cycle is

- (i) Die is closed and molten metal is ladled into the cold chamber cylinder;
- (ii) plunger pushes molten metal into die cavity; the metal is held under high pressure until it solidifies;
- (iii) die opens and plunger follows to push the solidified slug from the cylinder, if there are cores, they are retracted away;
- (iv) ejector pins push casting off ejector die and plunger returns to original position



This process is particularly useful for high melting point metals such as Aluminum, and Copper (and its alloys).

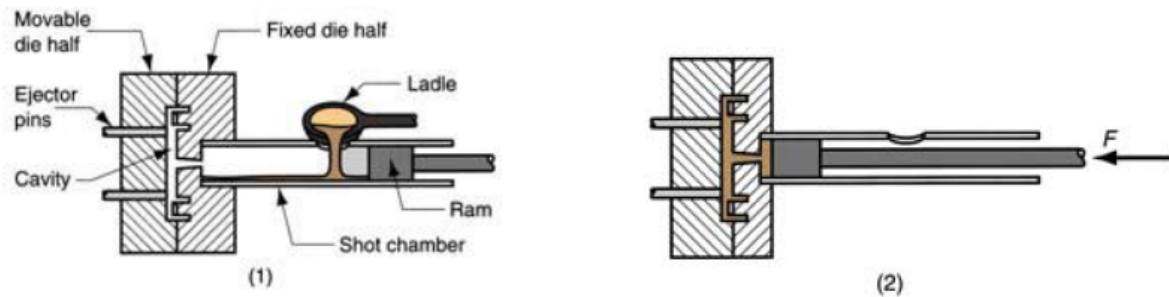

### Advantages

- Economical for large production quantities
- Good dimensional accuracy and surface finish
- Thin sections are possible
- Rapid cooling provides small grain size and good strength to casting

### Disadvantages

- Generally limited to metals with low metal points
- Part geometry must allow removal from die cavity

### Centrifugal casting

Centrifugal casting uses a permanent mold that is rotated about its axis at a speed between 300 to 3000 rpm as the molten metal is poured.

Centrifugal forces cause the metal to be pushed out towards the mold walls, where it solidifies after cooling.

Centrifugal casting has greater reliability than static castings. They are relatively free from gas and shrinkage porosity.

Surface treatments such as case carburizing, flame hardening and have to be used when wear resistant surface must be combined with a hard tough exterior surface.

One such application is bimetallic pipe consisting of two separate concentric layers of different alloys/metals bonded together.

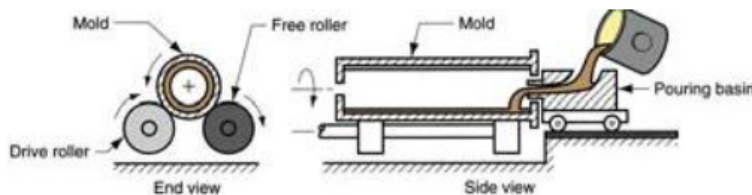

### Carbon Dioxide Moulding

- This sand is mixed with 3 to 5 % sodium silicate liquid base binder in a muller for 3 to 4 minutes. Additives such as coal powder, wood flour, sea coal, dextrine may be added to improve its properties.

- Aluminium oxide Kaolin clay may also be added to the sand.

- Patterns used in this method may be coated with Zinc of 0.05 mm to 0.13 mm and then spraying a layer of aluminium or brass of about 0.25 mm thickness for good surface finish and good results.

### Advantages

- Operation is speedy since we can use the mould and cores immediately after processing.
- Heavy and rush orders
- Floor space requirement is less
- Semi skilled labour may be used.

### Disadvantages

Difficult in reusing the moulding sand.

Process	Advantages	Disadvantages	Examples
Sand	Wide range of metals, sizes, shapes, low cost	poor finish, wide tolerance	engine blocks, cylinder heads
Shell mold	better accuracy, finish, higher production rate	limited part size	connecting rods, gear housings
Expendable pattern	Wide range of metals, sizes, shapes	patterns have low strength	cylinder heads, brake components
Plaster mold	complex shapes, good surface finish	non-ferrous metals, low production rate	prototypes of mechanical parts
Ceramic mold	complex shapes, high accuracy, good finish	small sizes	impellers, injection mold tooling
Investment	complex shapes, excellent finish	small parts, expensive	jewellery
Permanent mold	good finish, low porosity, high production rate	Costly mold, simpler shapes only	gears, gear housings
Die	Excellent dimensional accuracy, high production rate	costly dies, small parts, non-ferrous metals	precision gears, camera bodies, car wheels
Centrifugal	Large cylindrical parts, good quality	Expensive, limited shapes	pipes, boilers, flywheels

### Furnaces

#### Cupola Furnace

- A continuous flow of iron emerges from the bottom of the furnace.
- Depending on the size of the furnace, the flow rate can be as high as 100 tonnes per hour.

At the metal melts it is refined to some extent, which removes contaminants. This makes this process more suitable than electric furnaces for dirty charges.

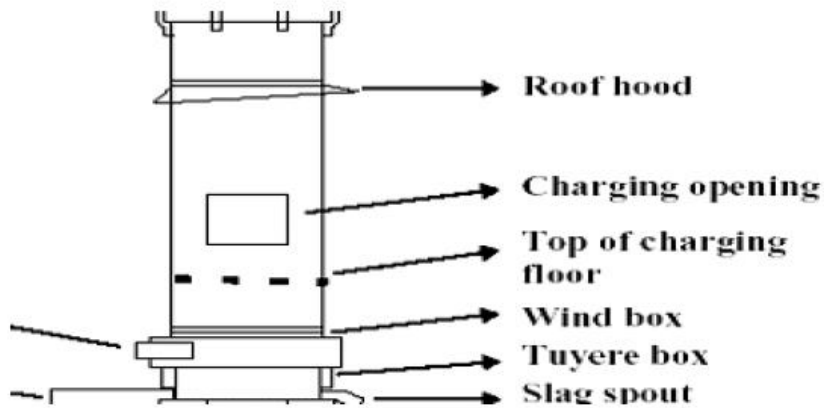

**Direct Fuel-fired furnace**

- Crucible Furnace
- Electric-arc Furnace
- Induction Furnace
- Pouring with ladle
- Solidification – watch for oxidation
- Trimming, surface cleaning, repair and heat treat, inspection

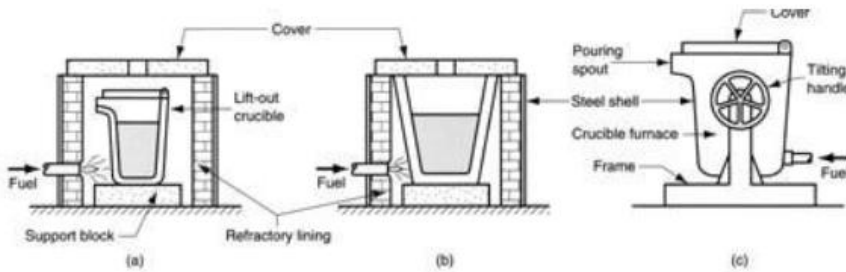

Three types: (a) lift-out crucible, (b) stationary pot, from which molten metal must be ladle (c) tilting-pot furnace

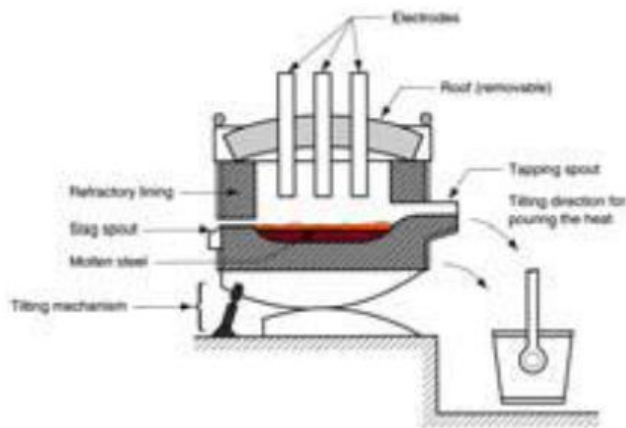

## Induction Furnace:

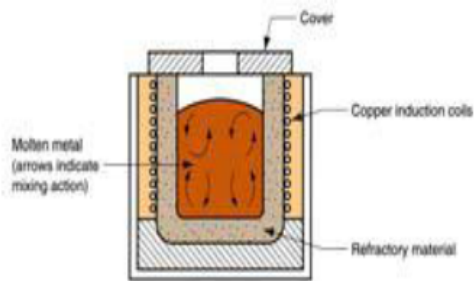

## Casting defects

Defects may occur due to one or more of the following reasons:

- Fault in design of casting pattern
- Fault in design on mold and core
- Fault in design of gating system and riser
- Improper choice of moulding sand
- Improper metal composition
- Inadequate melting temperature and rate of pouring

## Some common defects in castings:

a) Misruns b) Cold Shut c) Cold Shot d) Shrinkage Cavity e) Microporosity f) Hot Tearing

Misruns:

### a) Misruns

It is a casting that has solidified before completely filling the mold cavity.

Typical causes include

- 1) Fluidity of the molten metal is insufficient,
- 2) Pouring Temperature is too low,
- 3) Pouring is done too slowly and/or
- 4) Cross section of the mold cavity is too thin.

### b) Cold Shut

A cold shut occurs when two portion of the metal flow together, but there is lack of fusion between them due to premature freezing. Its causes are similar to those of a Misruns.

### c) Cold Shots

When splattering occurs during pouring, solid globules of the metal are formed that become entrapped in the casting. Poring procedures and gating system designs that avoid splattering can prevent these defects.

### d) Shrinkage Cavity

This defects is a depression in the surface or an internal void in the casting caused by solidification shrinkage that restricts the amount of the molten metal available in the last region to freeze.

### e) Microporosity

This refers to a network of a small voids distributed throughout the casting caused by localized solidification shrinkage of the final molten metal in the dendritic structure.

### f) Hot Tearing

This defect, also called hot cracking, occurs when the casting is restrained or early stages of cooling after solidification.

## UNIT-II

### WELDING -I

#### Welding

Welding is a materials joining process which produces coalescence of materials by heating them to suitable temperatures with or without the application of pressure or by the application of pressure alone, and with or without the use of filler material.

Welding is used for making permanent joints.

It is used in the manufacture of automobile bodies, aircraft frames, railway wagons, machine frames, structural works, tanks, furniture, boilers, general repair work and ship building.

#### Classification of welding processes

##### (i) Arc welding

- Carbon arc
- Metal arc
- Metal inert gas
- Tungsten inert gas
- Plasma arc
- Submerged arc
- Electro-slag

##### (ii) Gas Welding

- Oxy-acetylene
- Air-acetylene
- Oxy-hydrogen

##### iii) Resistance Welding

- Butt
- Spot
- Seam
- Projection
- Percussion

##### (iv) Thermit Welding

#### (v) Solid State Welding

- Friction
- Ultrasonic
- Diffusion
- Explosive

#### (vi) Newer Welding

- Electron-beam
- Laser

#### (vii) Related Process

- Oxy-acetylene cutting
- Arc cutting
- Hard facing
- Brazing
- Soldering

### Welding practice & equipment

STEPS :

- Prepare the edges to be joined and maintain the proper position
- Open the acetylene valve and ignite the gas at tip of the torch
- Hold the torch at about 45deg to the work piece plane
- Inner flame near the work piece and filler rod at about 30 – 40 deg
- Touch filler rod at the joint and control the movement according to the flow of the material

### Two Basic Types of AW Electrodes

- Consumable – consumed during welding process
  - Source of filler metal in arc welding
- Nonconsumable – not consumed during welding process
  - Filler metal must be added separately

### Consumable Electrodes

Forms of consumable electrodes

- Welding rods (a.k.a. sticks) are 9 to 18 inches and 3/8 inch or less in diameter and must be changed frequently
- Weld wire can be continuously fed from spools with long lengths of wire, avoiding frequent interruptions

In both rod and wire forms, electrode is consumed by arc and added to weld joint as filler metal.

### Nonconsumable Electrodes

- Made of tungsten which resists melting
- Gradually depleted during welding (vaporization is principal mechanism)
- Any filler metal must be supplied by a separate wire fed into weld pool

## Flux

A substance that prevents formation of oxides and other contaminants in welding, or dissolves them and facilitates removal

- Provides protective atmosphere for welding
- Stabilizes arc
- Reduces spattering

## Arc welding

Uses an electric arc to coalesce metals

Arc welding is the most common method of welding metals

Electricity travels from electrode to base metal to ground

## Arc welding Equipments

- A welding generator (D.C.) or Transformer (A.C.)
- Two cables- one for work and one for electrode
- Electrode holder
- Electrode
- Protective shield
- Gloves
- Wire brush
- Chipping hammer
- Goggles

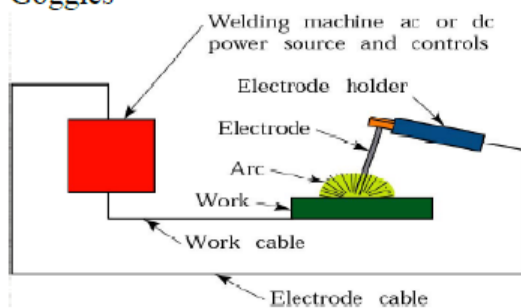

## Advantages

- Most efficient way to join metals
- Lowest-cost joining method
- Affords lighter weight through better utilization of materials
- Joins all commercial metals
- Provides design flexibility

## Disadvantages

- Manually applied, therefore high labor cost.
- Need high energy causing danger
- Not convenient for disassembly.
- Defects are hard to detect at joints.

## GAS WELDING

- Sound weld is obtained by selecting proper size of flame, filler material and method of moving torch
- The temperature generated during the process is 33000c.
- When the metal is fused, oxygen from the atmosphere and the torch combines with molten metal and forms oxides, results defective weld
- Fluxes are added to the welded metal to remove oxides
- Common fluxes used are made of sodium, potassium. Lithium and borax.
- Flux can be applied as paste, powder, liquid. solid coating or gas.

## GAS WELDING EQUIPMENT

### 1. Gas Cylinders

Pressure

Oxygen – 125 kg/cm<sup>2</sup>

Acetylene – 16 kg/cm<sup>2</sup>

### 2. Regulators

Working pressure of oxygen 1 kg/cm<sup>2</sup>

Working pressure of acetylene 0.15 kg/cm<sup>2</sup>

Working pressure varies depends upon the thickness of the work pieces welded.

### 3. Pressure Gauges

### 4. Hoses

### 5. Welding torch

### 6. Check valve

### 7. Non return valve

## Types of Flames

- Oxygen is turned on, flame immediately changes into a long white inner area (Feather) surrounded by a transparent blue envelope is called **Carburizing flame** (30000c)
- Addition of little more oxygen give a bright whitish cone surrounded by the transparent blue envelope is called **Neutral flame** (It has a balance of fuel gas and oxygen) (32000c)
- Used for welding steels, aluminium, copper and cast iron
- If more oxygen is added, the cone becomes darker and more pointed, while the envelope becomes shorter and more fierce is called **Oxidizing flame**
- Has the highest temperature about 34000c
- Used for welding brass and brazing operation



(a) Neutral flame

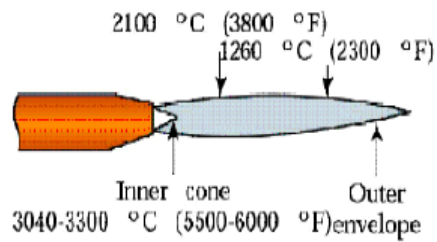

(b) Oxidizing flame

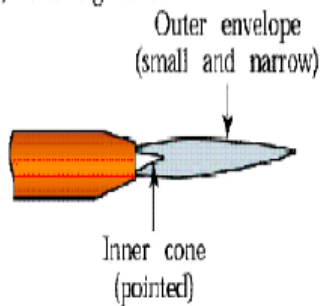

(c) Carburizing (reducing) flame

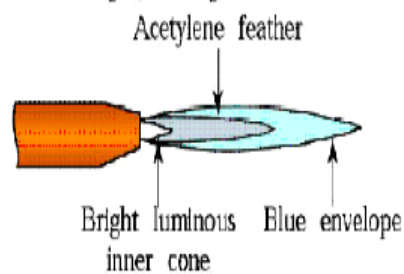

Three basic types of oxyacetylene flames used in oxyfuel-gas welding and cutting operations:

(a) neutral flame; (b) oxidizing flame; (c) carburizing, or reducing flame.

### Fusion welding processes

- Definition : Fusion Welding is defined as melting together and coalescing materials by means of heat
- Energy is supplied by thermal or electrical means
- Fusion welds made without filler metals are known as autogenous welds

### Filler Metals:

- Additional material to weld the weld zone
- Available as rod or wire
- They can be used bare or coated with flux
- The purpose of the flux is to retard the

## Shielded metal arc welding process

- An electric arc is generated between a coated electrode and the parent metal
- The coated electrode carries the electric current to form the arc, produces a gas to control the atmosphere and provides filler metal for the weld bead
- Electric current may be AC or DC. If the current is DC, the polarity will affect the weld size and application

### Process

- Intense heat at the arc melts the tip of the electrode
- Tiny drops of metal enter the arc stream and are deposited on the parent metal
- As molten metal is deposited, a slag forms over the bead which serves as an insulation against air contaminants during cooling
- After a weld 'pass' is allowed to cool, the oxide layer is removed by a chipping hammer and then cleaned with a wirebrush before the next pass.

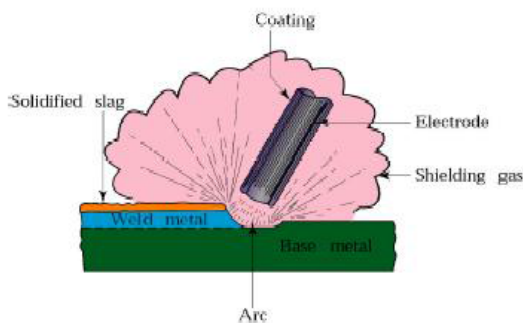

Fig : Schematic illustration of the shielded metal-arc welding process. About 50% of all large-scale industrial welding operations use this process.

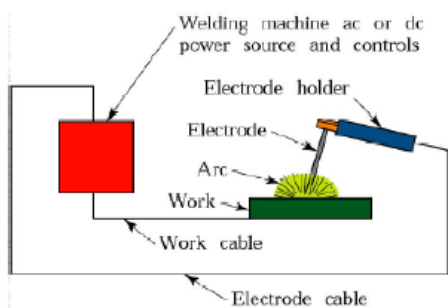

Fig : Schematic illustration of the shielded metal-arc welding process ( also known as stick welding, because the electrode is in the shape of a stick).

## Submerged arc welding

- Weld arc is shielded by a granular flux , consisting of silica, lime, manganese oxide, calcium fluoride and other compounds.
- Flux is fed into the weld zone by gravity flow through nozzle

- Thick layer of flux covers molten metal
- Flux acts as a thermal insulator ,promoting deep penetration of heat into the work piece
- Consumable electrode is a coil of bare round wire fed automatically through a tube
- Power is supplied by 3-phase or 2-phase power lines

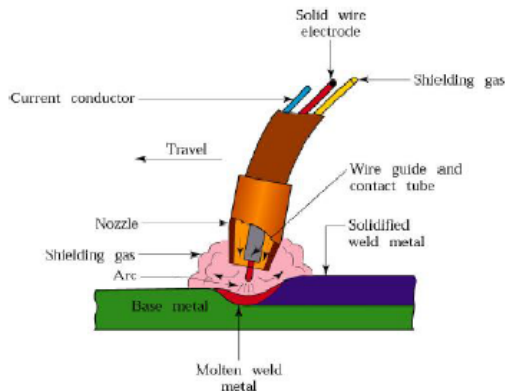

Fig : Schematic illustration of the submerged-arc welding process and equipment. The unfused flux is recovered and reused.

### Gas metal arc welding

- GMAW is a metal inert gas welding (MIG)
- Weld area shielded by an effectively inert atmosphere of argon, helium, carbon dioxide, various other gas mixtures
- Metal can be transferred by 3 methods :
- Spray transfer
- Globular transfer
- Short circuiting

### Process capabilities

- GMAV process is suitable for welding a variety of ferrous and non-ferrous metals
- Process is versatile ,rapid, economical, welding productivity is double that of SMAW

### Flux cored arc welding

- Flux cored arc welding is similar to a gas metal arc welding
- Electrode is tubular in shape and is filled with flux
- Cored electrodes produce more stable arc improve weld contour and produce better mechanical properties
- Flux is more flexible than others

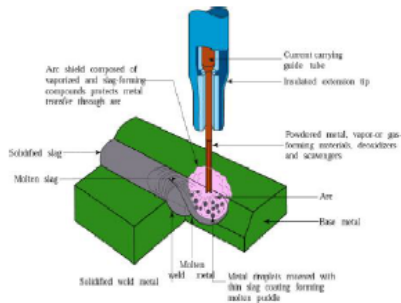

Fig : Schematic illustration of the flux-cored arc-welding process. This operation is similar to gas metal-arc welding.

### Electro gas Welding

- EGW is welding the edges of sections vertically in one pass with the pieces placed edge to edge
- Similar to Electro gas welding
- Weld metal is deposited into weld cavity between the two pieces to be joined
- Difference is Arc is started between electrode tip and bottom part of the part to be welded
- Flux added first and then melted by the heat on the arc
- Molten slag reaches the tip of the electrode and the arc is extinguished
- Heat is then continuously produced by electrical resistance of the molten slag
- Single or multiple solid as well as flux-cored electrodes may be used

### Process capabilities

- Weld thickness ranges from 12mm to 75mm
- Metals welded are steels, titanium, aluminum alloys
- Applications are construction of bridges, pressure vessels, thick walled and large diameter pipes, storage tanks and ships.

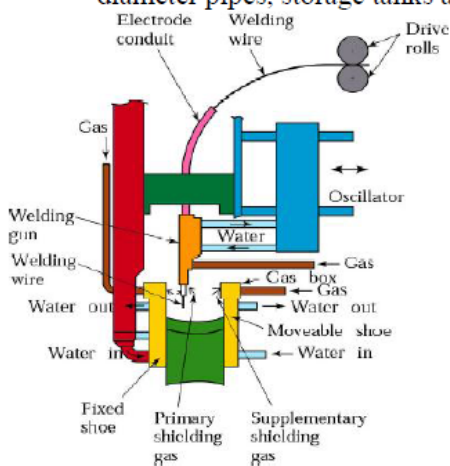

Fig : Schematic illustration of the electrogas welding process

### Brazing

## UNIT-III

### WELDING-II

#### BRAZING

It is a low temperature joining process. It is performed at temperatures above 840° F and it generally affords strengths comparable to those of the metal which it joins. It is low temperature in that it is done below the melting point of the base metal. It is achieved by diffusion without fusion (melting) of the base

#### Brazing can be classified as

Torch brazing

Dip brazing

Furnace brazing

Induction brazing

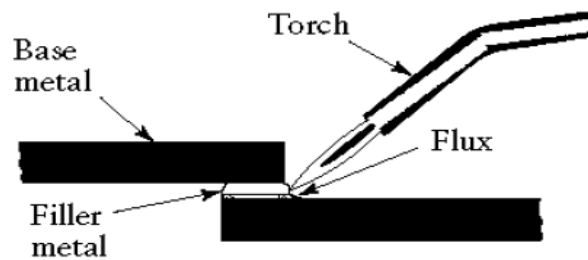

#### Advantages

- Dissimilar metals which cannot be welded can be joined by brazing
- Very thin metals can be joined
- Metals with different thickness can be joined easily
- In brazing thermal stresses are not produced in the work piece. Hence there is no distortion
- Using this process, carbides tips are brazed on the steel tool holders

#### Disadvantages

- Brazed joints have lesser strength compared to welding
- Joint preparation cost is more
- Can be used for thin sheet metal sections

#### Soldering

- It is a low temperature joining process. It is performed at temperatures below 840°F for joining.
- Soldering is used for,
  - Sealing, as in automotive radiators or tin cans
  - Electrical Connections
  - Joining thermally sensitive components
  - Joining dissimilar metals

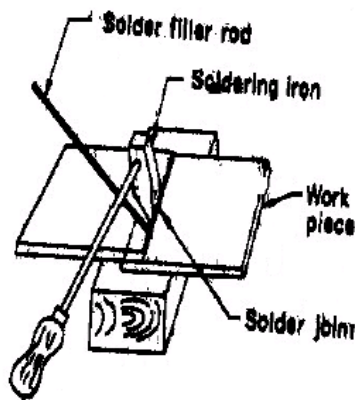

### Inert Gas Welding

For materials such as Al or Ti which quickly form oxide layers, a method to place an inert atmosphere around the weld puddle had to be developed

### Metal Inert Gas (MIG)

- Uses a consumable electrode (filler wire made of the base metal)
- Inert gas is typically Argon

### Gas Tungsten Arc Welding (GTAW)

Uses a non-consumable tungsten electrode and an inert gas for arc shielding

- Melting point of tungsten = 3410°C (6170°F)
- A.k.a. Tungsten Inert Gas (TIG) welding
  - In Europe, called "WIG welding"
- Used with or without a filler metal
  - When filler metal used, it is added to weld pool from separate rod or wire
- Applications: aluminum and stainless steel most common

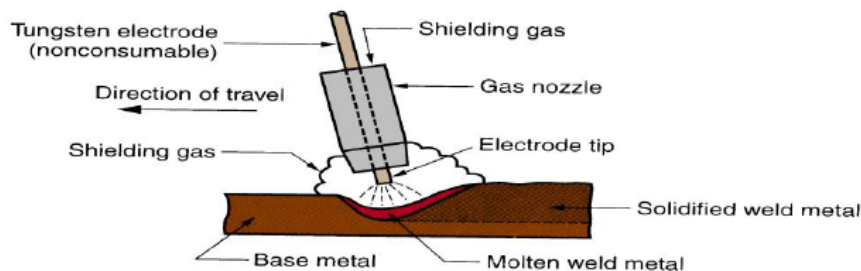

### Advantages

- High quality welds for suitable applications
- No spatter because no filler metal through arc
- Little or no post-weld cleaning because no flux

### Disadvantages

- Generally slower and more costly than consumable electrode AW processes

### Plasma Arc Welding (PAW)

Special form of GTAW in which a constricted plasma arc is directed at weld area

- Tungsten electrode is contained in a nozzle that focuses a high velocity stream of inert gas (argon) into arc region to form a high velocity, intensely hot plasma arc stream
- Temperatures in PAW reach 28,000°C (50,000°F), due to constriction of arc, producing a plasma jet of small diameter and very high energy density

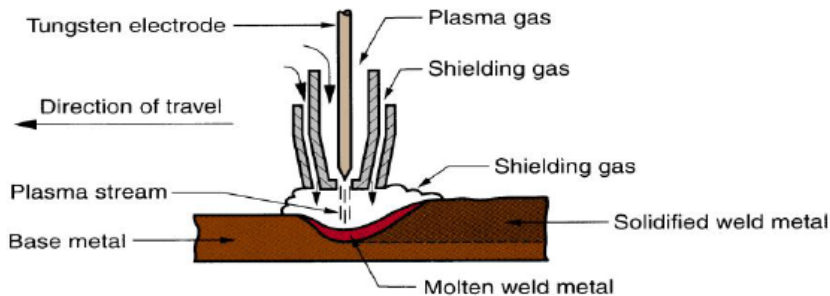

### Resistance Welding (RW)

A group of fusion welding processes that use a combination of heat and pressure to accomplish coalescence

- Heat generated by electrical resistance to current flow at junction to be welded
- Principal RW process is resistance spot welding (RSW)

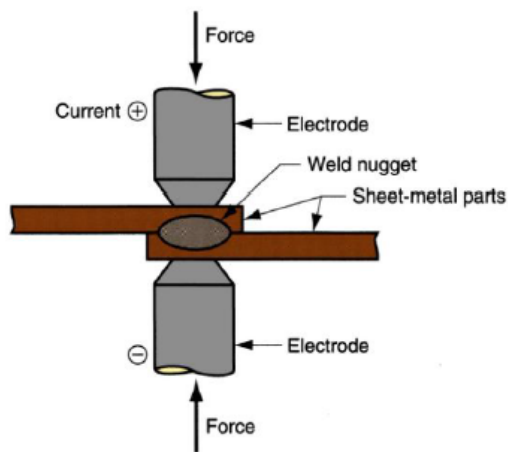

Fig: Resistance welding, showing the components in spot welding, the main process in the RW group.

### Components in Resistance Spot Welding

- Parts to be welded (usually sheet metal)
- Two opposing electrodes
- Means of applying pressure to squeeze parts between electrodes
- Power supply from which a controlled current can be applied for a specified time duration

### Advantages

- No filler metal required

- High production rates possible
- Lends itself to mechanization and automation
- Lower operator skill level than for arc welding
- Good repeatability and reliability

#### Disadvantages

- High initial equipment cost
- Limited to lap joints for most RW processes

### Resistance Seam Welding

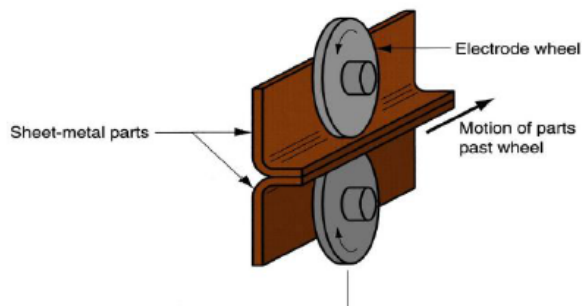

### Electron Beam Welding (EBW)

Fusion welding process in which heat for welding is provided by a highly-focused, high-intensity stream of electrons striking work surface

- Electron beam gun operates at:
  - High voltage (e.g., 10 to 150 kV typical) to accelerate electrons
  - Beam currents are low (measured in milliamps)
- Power in EBW not exceptional, but power density is

#### Advantages

- High-quality welds, deep and narrow profiles
- Limited heat affected zone, low thermal distortion
- High welding speeds
- No flux or shielding gases needed

#### Disadvantages

- High equipment cost
- Precise joint preparation & alignment required
- Vacuum chamber required
- Safety concern: EBW generates x-rays

### Laser Beam Welding (LBW)

Fusion welding process in which coalescence is achieved by energy of a highly concentrated, coherent light beam focused on joint

- Laser = "light amplification by stimulated emission of radiation"
- LBW normally performed with shielding gases to prevent oxidation



- Filler metal not usually added
- High power density in small area, so LBW often used for small parts

### Comparison: LBW vs. EBW

- No vacuum chamber required for LBW
- No x-rays emitted in LBW
- Laser beams can be focused and directed by optical lenses and mirrors
- LBW not capable of the deep welds and high depth-to-width ratios of EBW
  - Maximum LBW depth =  $\sim 19$  mm (3/4 in), whereas EBW depths = 50 mm (2 in)

### Thermit Welding (TW)

FW process in which heat for coalescence is produced by superheated molten metal from the chemical reaction of thermit

- Thermit = mixture of Al and  $Fe_3O_4$  fine powders that produce an exothermic reaction when ignited
- Also used for incendiary bombs
- Filler metal obtained from liquid metal
- Process used for joining, but has more in common with casting than welding

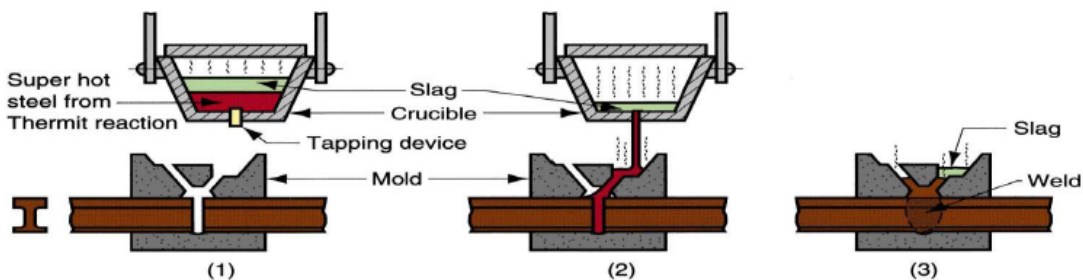

Fig: Thermit welding: (1) Thermit ignited; (2) crucible tapped, superheated metal flows into mold; (3) metal solidifies to produce weld joint.

### Applications

- Joining of railroad rails
- Repair of cracks in large steel castings and forgings
- Weld surface is often smooth enough that no finishing is required

### Diffusion Welding (DFW)

SSW process uses heat and pressure, usually in a controlled atmosphere, with sufficient time for diffusion and coalescence to occur

- Temperatures  $\leq 0.5 T_m$
- Plastic deformation at surfaces is minimal
- Primary coalescence mechanism is solid state diffusion
- Limitation: time required for diffusion can range from seconds to hours

## Applications

- Joining of high-strength and refractory metals in aerospace and nuclear industries
- Can be used to join either similar and dissimilar metals
- For joining dissimilar metals, a filler layer of different metal is often sandwiched between base metals to promote diffusion

## Friction Welding (FRW)

SSW process in which coalescence is achieved by frictional heat combined with pressure

- When properly carried out, no melting occurs at faying surfaces
- No filler metal, flux, or shielding gases normally used
- Process yields a narrow HAZ
- Can be used to join dissimilar metals
- Widely used commercial process, amenable to automation and mass production

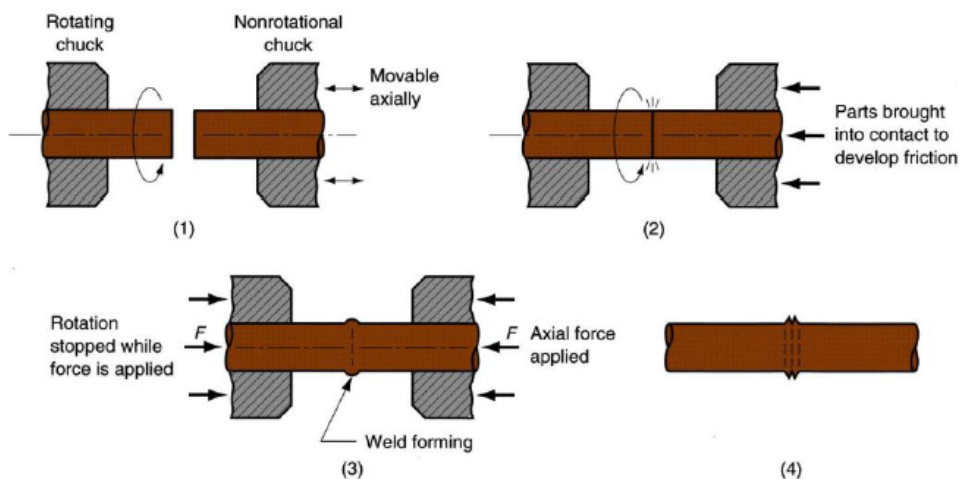

Fig: Friction welding (FRW): (1) rotating part, no contact; (2) parts brought into contact to generate friction heat; (3) rotation stopped and axial pressure applied; and (4) weld created.

## Applications

- Shafts and tubular parts
- Industries: automotive, aircraft, farm equipment, petroleum and natural gas

## Limitations

- At least one of the parts must be rotational
- Flash must usually be removed
- Upsetting reduces the part lengths (which must be taken into consideration in product design)

## Weld Defects

- Undercuts/Overlaps
- Grain Growth

A wide  $\Delta T$  will exist between base metal and HAZ. Preheating and cooling methods will affect the brittleness of the metal in this region

- Blowholes

Are cavities caused by gas entrapment during the solidification of the weld puddle. Prevented by proper weld technique (even temperature and speed)

- Inclusions

Impurities or foreign substances which are forced into the weld puddle during the welding process. Has the same effect as a crack. Prevented by proper technique/cleanliness.

- Segregation

Condition where some regions of the metal are enriched with an alloy ingredient and others aren't. Can be prevented by proper heat treatment and cooling.

- Porosity

The formation of tiny pinholes generated by atmospheric contamination.

Prevented by keeping a protective shield over the molten weld puddle.

## UNIT-IV

### FORMING PROCESS

#### Cold working

The process is usually performed at room temperature, but mildly elevated temperatures may be used to provide increased ductility and reduced strength

For example: Deforming lead at room temperature is a hot working process because the recrystallization temperature of lead is about room temperature.

#### Effects of Cold Working

Deformation using cold working results in

- Higher stiffness, and strength, but
- Reduced malleability and ductility of the metal.
- Anisotropy

#### Advantages

- No heating is required
- Strength, fatigue and wear properties are improved through strain hardening
- Superior dimensional control is achieved, so little, if any, secondary machining is required
- Better surface finish is obtained
- Products possess better reproducibility and interchangeability
- Directional properties can be imparted
- Contamination problems are minimized

#### Disadvantages

- Higher forces are required to initiate and complete the deformation
- Less ductility is available
- Intermediate anneals may be required to compensate for the loss of ductility that accompanies strain hardening
- Heavier and more powerful equipment is required
- Metal surfaces must be clean and scale-free
- Imparted directional properties may be detrimental
- Undesirable residual stresses may be produced

#### Hot working

Hot working is the deformation that is carried out above the recrystallization temperature.

#### Effects of hot working

· At high temperature, scaling and oxidation exist. Scaling and oxidation produce undesirable surface finish. Most ferrous metals need to be cold worked after hot working in order to improve the surface finish.

- The amount of force needed to perform hot working is less than that for cold work.
- The mechanical properties of the material remain unchanged during hot working.

· The metal usually experiences a decrease in yield strength when hot worked. Therefore, it is possible to hot work the metal without causing any fracture.

Quenching is the sudden immersion of a heated metal into cold water or oil. It is used to make the metal very hard. To reverse the effects of quenching, tempering is used (reheated of the metal for a period of time)

To reverse the process of quenching, tempering is used, which is the reheat of the metal.

### Cold-working Processes

- Squeezing
- Bending
- Shearing
- Drawing
- Presses

### Classifications of Squeezing Processes

- Rolling
- Cold Forging
- Sizing
- Staking
- Staking
- Coining
- Burnishing
- Extrusion
- Peening
- Hubbing
- Riveting
- Thread Rolling

### ROLLING

Process used in sheets, strips, bars, and rods to obtain products that have smooth surfaces and accurate dimensions; most cold-rolling is performed on four-high or cluster-type rolling mills



ROLLING PROCESS

### Flat Rolling

A sheet or block or strip stock is introduced between rollers and then compressed and squeezed. Thickness is reduced. The amount of strain (deformation) introduced determines the hardness, strength and other material properties of the finished product. Used to produce sheet metals predominantly

### Swaging

Process that reduces/increases the diameter, tapers, rods or points round bars or tubes by external hammering

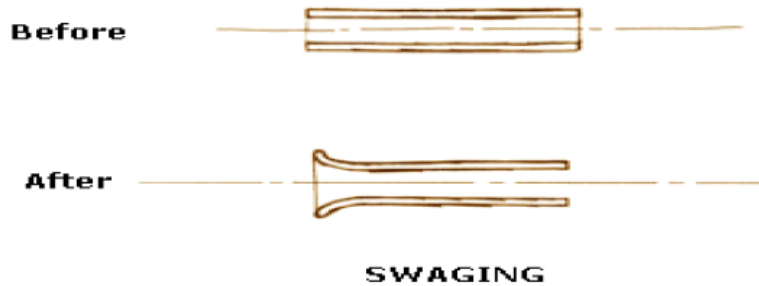

### Cold Forging

Process in which slugs of material are squeezed into shaped die cavities to produce finished parts of precise shape and size.



### COLD HEADING/COLD FORGING

### Extrusion

Process which is commonly used to make collapsible tubes such as toothpaste tubes, cans usually using soft materials such as aluminum, lead, tin. Usually a small shot of solid material is placed in the die and is impacted by a ram, which causes cold flow in the material.

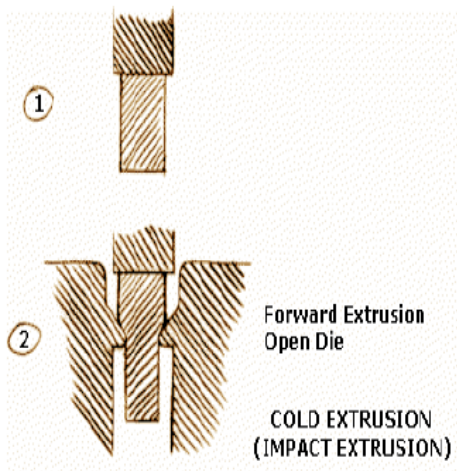

### Sizing

Process of squeezing all or selected areas of forgings, ductile castings, or powder metallurgy products to achieve a desired thickness or precision

### Riveting

Process where a head is formed on the shank end of a fastener to permanently join sheets or plates of material;

### Staking

Process of permanently joining parts together when one part protrudes through a hole in the other; a shaped punch is driven into the end of the protruding piece where a deformation is formed causing a radial expansion, mechanically locking the two pieces together

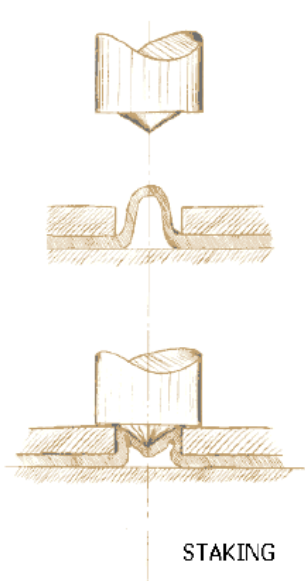

### Coining

Process where metal while it is confined in a closed set of dies; used to produce coins, medals, and other products where exact size and fine details are required, and thickness varies about a well-defined average

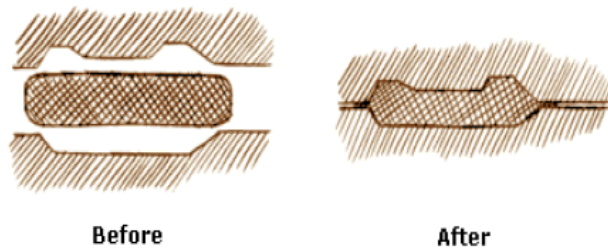

COINING

### Peening

Process where the surface of the metal is blasted by shot pellets; the mechanical working of surfaces by repeated blows of impelled shot or a round-nose tool

### Burnishing

Process by which a smooth hard tools is rubbed on the metal surface and flattens the high spots by applying compressive force and plastically flowing the material

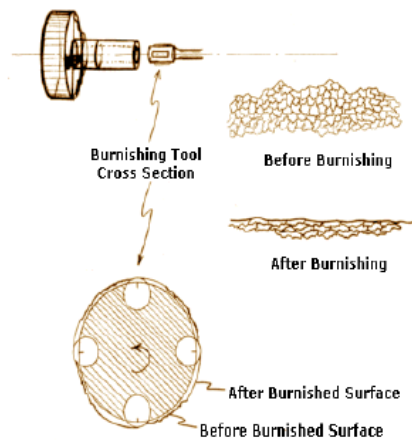

BURNISHING

### Hubbing

Process is used to form recessed cavities in various types of female tooling dies. This is often used to make plastic extrusion dies in an economical manner



### Thread Rolling

Process is used for making external threads; in this process, a die, which is a hardened tool with the thread profile, is pressed on to a rotating workpiece



THREAD ROLLING

### The Presses

There are many kinds of machines

- Hydraulic presses
- Mechanical presses
  - C frame
  - Straight sided
- Others

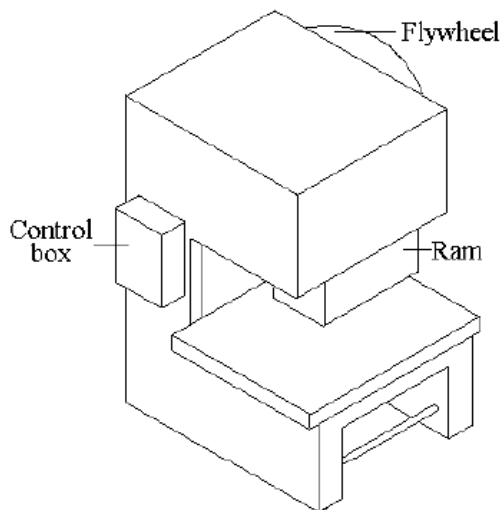

C-frame mechanical press

## UNIT-V

### FORGING, EXTRUSION PROCESS

#### Types of Forging Presses

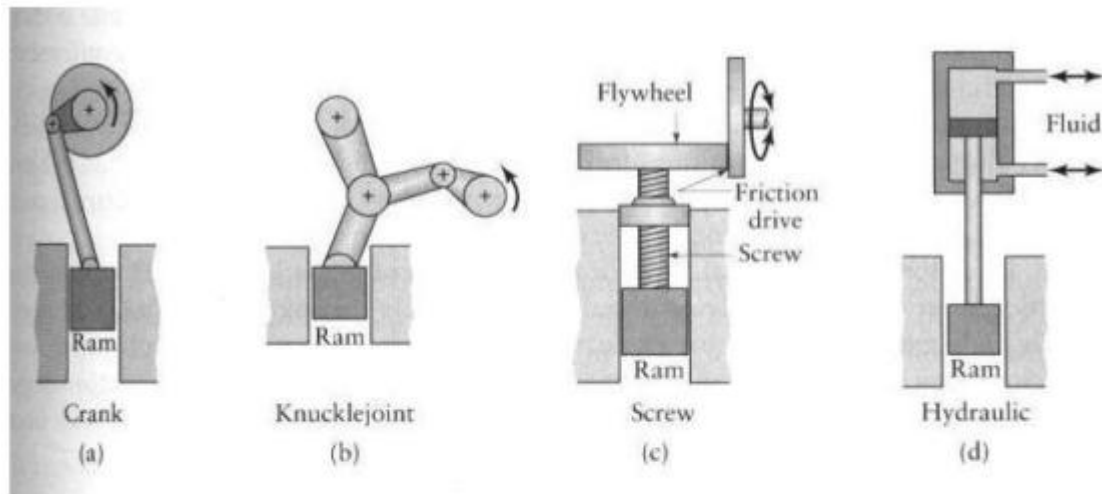

#### Impression Die Forging

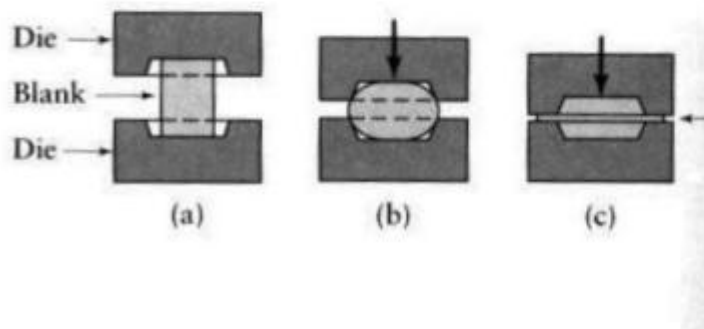

## Forging operations

Forging is a process in which the workpiece is shaped by compressive forces applied through various dies and tools. It is one of the oldest metalworking operations. Most forgings require a set of dies and a press or a forging hammer.

A Forged metal can result in the following: -

- Decrease in height, increase in section - open die forging
- Increase length, decrease cross-section, called drawing out.
- Decrease length, increase in cross-section on a portion of the length - upsetting
- Change length, change cross-section, by squeezing in closed impression dies - closed die forging. This results in favorable grain flow for strong parts

## Types of forging

- Closed/impression die forging
- Electro-upsetting
- Forward extrusion
- Backward extrusion
- Radial forging
- Hobbing
- Isothermal forging
- Open-die forgig
- Upsetting
- Nosing
- Coining

Commonly used materials include

- Ferrous materials: low carbon steels
- Nonferrous materials: copper, aluminum and their alloys

## Open-Die Forging

Open-die forging is a hot forging process in which metal is shaped by hammering or pressing between flat or simple contoured dies.

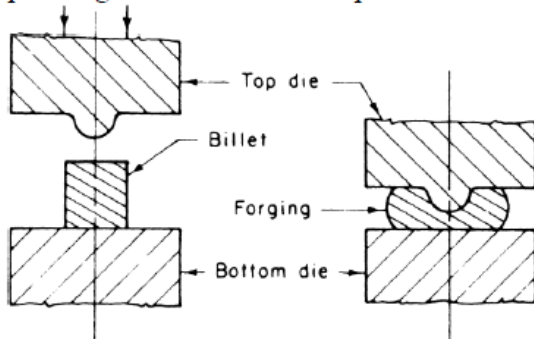

**Equipment.** Hydraulic presses, hammers.

**Materials.** Carbon and alloy steels, aluminum alloys, copper alloys, titanium alloys, all forgeable materials.

**Process Variations.** Slab forging, shaft forging, mandrel forging, ring forging, upsetting between flat or curved dies, drawing out.

**Application.** Forging ingots, large and bulky forgings, preforms for finished forgings.

### Closed Die Forging

In this process, a billet is formed (hot) in dies (usually with two halves) such that the flow of metal from the die cavity is restricted. The excess material is extruded through a restrictive narrow gap and appears as flash around the forging at the die parting line.

**Equipment.** Anvil and counterblow hammers, hydraulic, mechanical, and screw presses.

**Materials.** Carbon and alloy steels, aluminum alloys, copper alloys, magnesium alloys, beryllium, stainless steels, nickel alloys, titanium and titanium alloys, iron and nickel and cobalt super alloys.

**Process Variations.** Closed-die forging with lateral flash, closed-die forging with longitudinal flash, closed-die forging without flash.

**Application.** Production of forgings for automobiles, trucks, tractors, off-highway equipment, aircraft, railroad and mining equipment, general mechanical industry, and energy-related engineering production.

### Forward extrusion

Forward extrusion reduces slug diameter and increases its length to produce parts such as stepped shafts and cylinders.

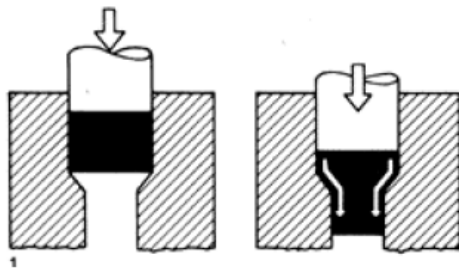

### backward extrusion

In backward extrusion, the steel flows back and around the descending punch to form cup-shaped pieces.

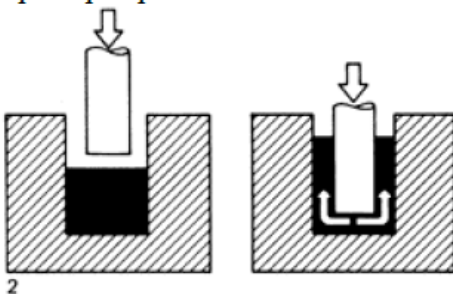

### Upsetting, or heading

Upsetting, or heading, a common technique for making fasteners, gathers steel in the head and other sections along the length of the part.

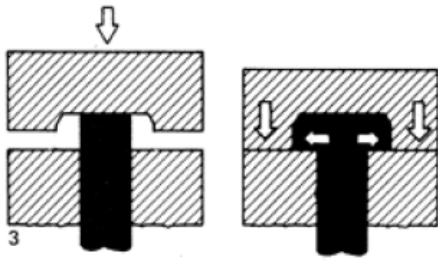

### Electro-Upsetting (Fig. 2.4)

Electro-upsetting is the hot forging process of gathering a large amount of material at one end of a round bar by heating the bar end electrically and pushing it against a flat anvil or shaped die cavity.

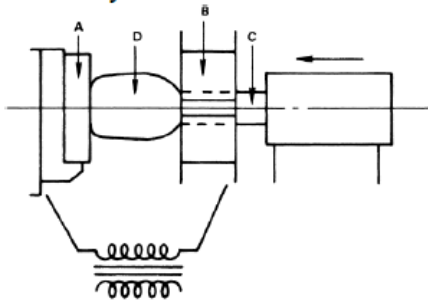

A, anvil electrode; B, gripping electrode; C, workpiece; D, upset end of workpiece

**Equipment.** Electric upsetters.

**Materials.** Carbon and alloy steels, titanium.

**Application.** Preforms for finished forgings.

### Hobbing

Hobbing is the process of indenting or coining an impression into a cold or hot die block by pressing with a punch.

**Equipment.** Hydraulic presses, hammers.

**Materials.** Carbon and alloy steels.

**Process Variations.** Die hobbing, die typing.

**Application.** Manufacture of dies and molds with relatively shallow impressions.

### Nosing

Nosing is a hot or cold forging process in which the open end of a shell or tubular component is closed by axial pressing with a shaped die.

**Equipment.** Mechanical and hydraulic presses, hammers.

**Materials.** Carbon and alloy steels, aluminum alloys, titanium alloys.

**Process Variations.** Tube sinking, tube expanding.

**Applications.** Forging of open ends of ammunition shells; forging of gas pressure containers.

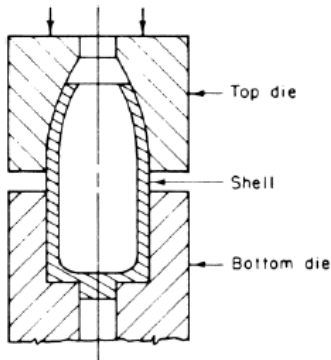

### Coining

In sheet metal working, coining is used to form indentations and raised sections in the part. During the process, metal is intentionally thinned or thickened to achieve the required indentations or raised sections. It is widely used for lettering on sheet metal or components such as coins. Bottoming is a type of coining process where bottoming pressure causes reduction in thickness at the bending area.

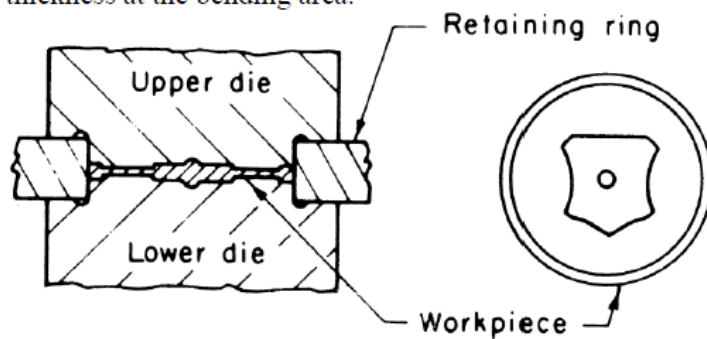

### Ironing

Ironing is the process of smoothing and thinning the wall of a shell or cup (cold or hot) by forcing the shell through a die with a punch.

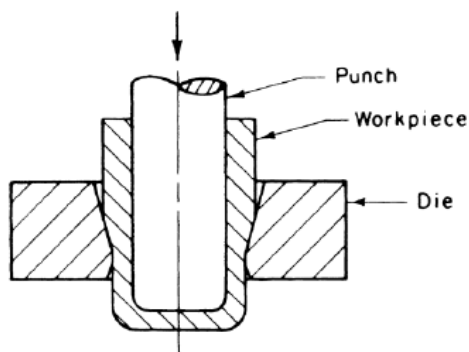

**Equipment.** Mechanical presses and hydraulic presses.

**Materials.** Carbon and alloy steels, aluminum and aluminum alloys, titanium alloys.

**Applications.** Shells and cups for various

## Swaging

Uses hammering dies to decrease the diameter of the part

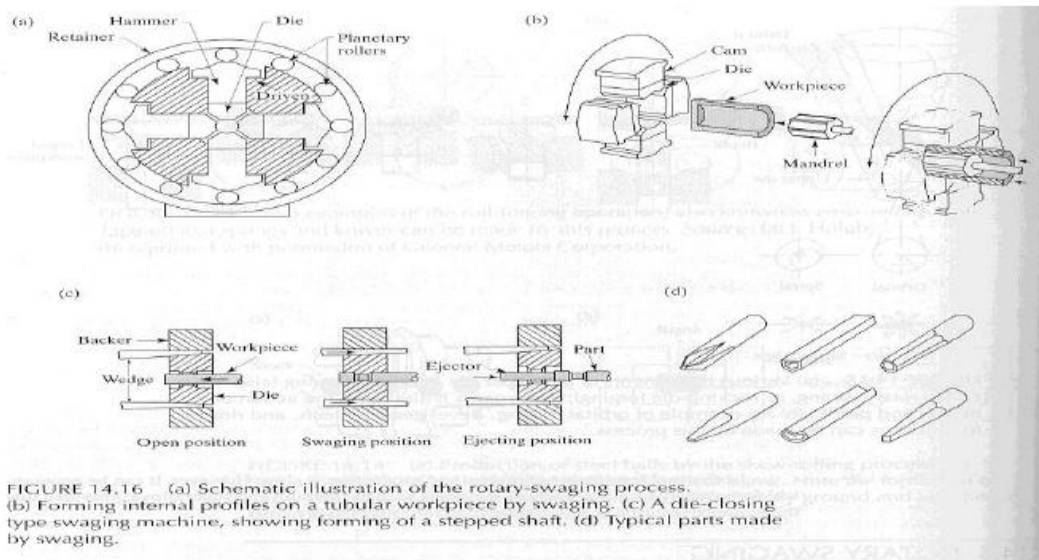

## Defects in Forging

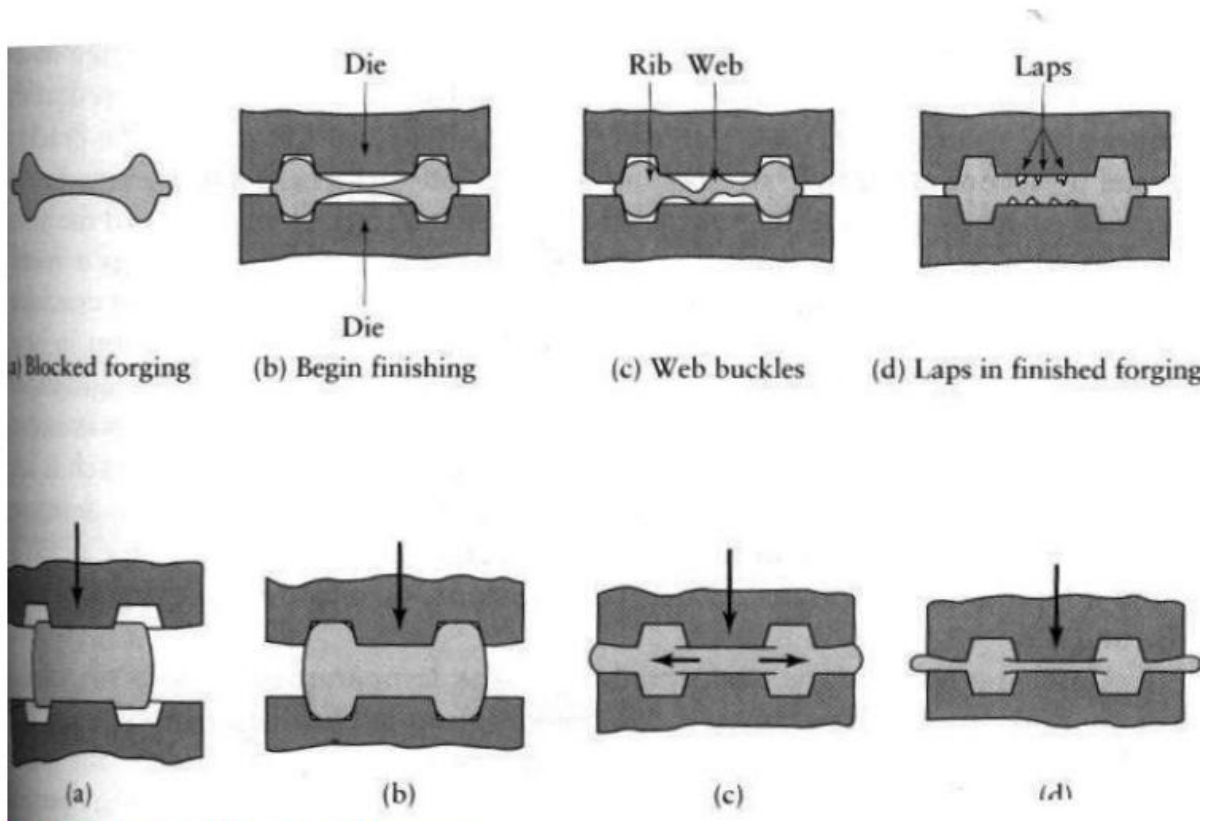

## Extrusion and Drawing Processes

### **Extrusion**

Process by which long straight metal parts can be produced.

Cross-sections that can be produced vary from solid round, rectangular, to L shapes, T Shapes, tubes and many other different types

Done by squeezing metal in a closed cavity through a die using either a mechanical or hydraulic press.

Extrusion produces compressive and shear forces in the stock.

No tension is produced, which makes high deformation possible without tearing the metal.

Can be done Hot or cold

### **Drawing**

Section of material reduced by pulling through die.

Similar to extrusion except material is under TENSILE force since it is pulled through the die

Various types of sections: - round, square, profiles

### **Tube Drawing**

Utilizes a special tool called a MANDREL is inserted in a tube hollow section to draw a seamless tube

- Mandrel and die reduce both the tube's outside diameter and its wall thickness. The mandrel also makes the tube's inside surface smoother



### Sheet Metal Forming

Involves methods in which sheet metal is cut into required dimensions and shape; and/or forming by stamping, drawing, or pressing to the final shape

A special class of metal forming where the thickness of the piece of material is small compared to the other dimensions

Cutting into shape involve shear forces

Forming Processes involve tensile stresses

The Major operations of sheet Metal are;

- 1) Shearing,
- 2) Bending,
- 3) Drawing and
- 4) Squeezing

### Shearing

The mechanical cutting of materials without the information of chips or the use of burning or melting for straight cutting blades: shearing for curved blades: blanking, piercing, notching, trimming

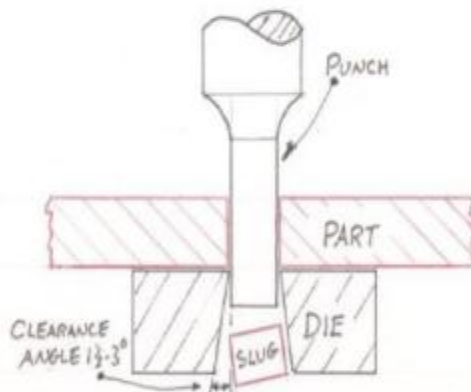

### Classifications of Shearing Processes

- Slitting
- Piercing
- Blanking
- Notching
- Shaving
- Trimming
- Cutoff
- Dinking

### Slitting

3. Discuss the various forging operations and its types. (16)

shearing process used to cut rolls of sheet metal into several rolls of narrower width  
used to cut a wide coil of metal into a number of narrower coils as the main coil is moved through the slitter.

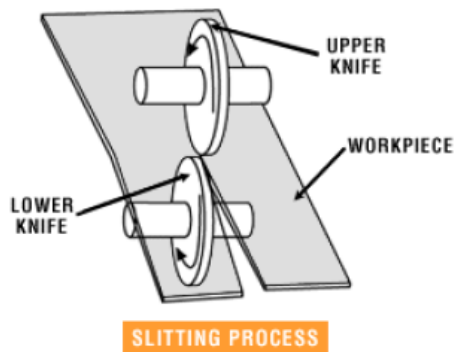

### Blanking

during which a metal workpiece is removed from the primary metal strip or sheet when it is punched.

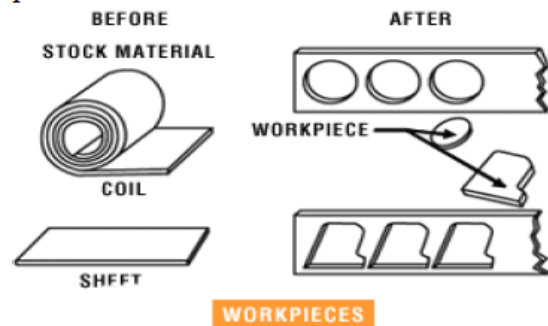

### Piercing

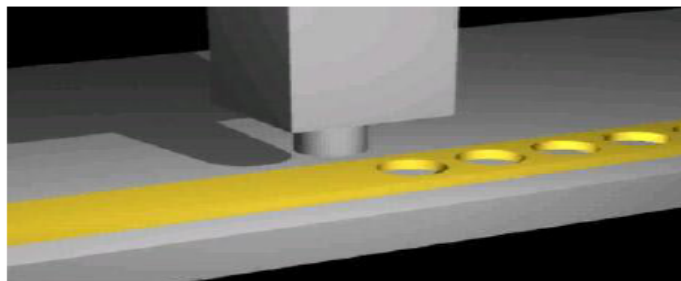

### Notching

same as piercing

- edge of the strip or blank forms part of the punch-out perimeter

### Nibbling

Produces a series of overlapping slits/notches

### Shaving

- finishing operation in which a small amount of metal is sheared away from the edge of an already blanked part
- can be used to produce a smoother edge

### Trimming



### Cutoff

Punch and die operation used to separate a stamping or other product from a strip or stock

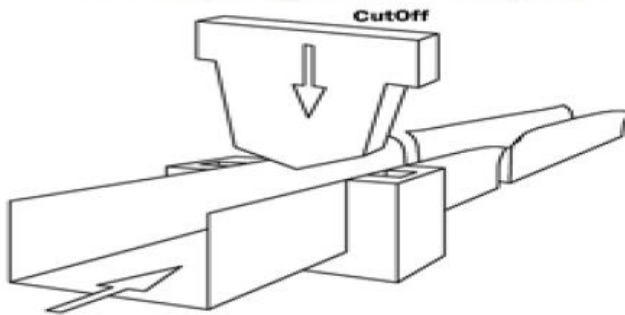

### Dinking

Used to blank shapes from low-strength materials such as rubber, fiber and cloth

### Bending

The plastic deformation of metals about a linear axis with little or no change in the surface area.

The purpose of bending is to form sheet metal along a straight line

### Springback

The elastic recovery of the material after unloading of the tools

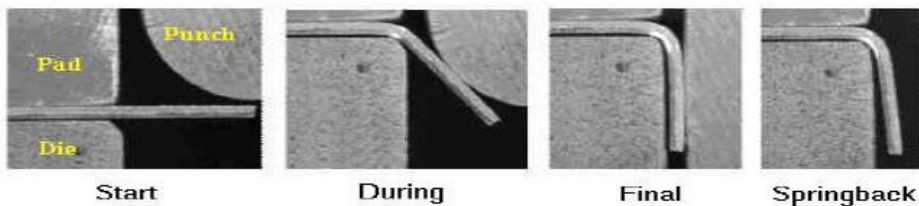

To compensate with the unbending action of the springback, the metal should be slightly overbent.

### Classifications of Bending Processes

- Angle
- Straightening
- Roll Forming
- Draw and Compression
- Seaming
- Roll
- Flanging

### Roll Bending

Bending where plates, sheets and rolled shapes can be bent to a desired curvature  
Roll bending toll can bend plate up to 6 inches thick

### Angle Bending

#### Profiles:

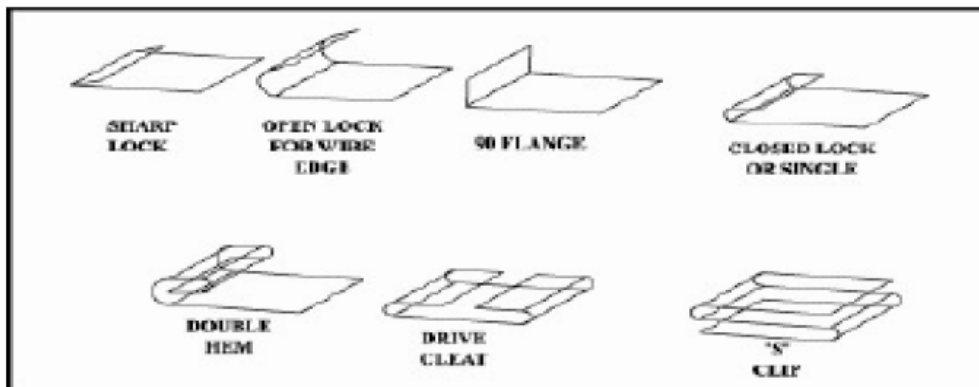

### Drawing Bending

Workpiece is clamped against a bending form and the entire assemble rotates to draw the workpiece across a stationary tool

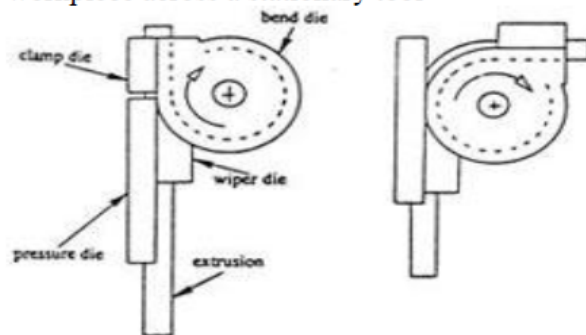

### Compression Bending

The bending form remains stationary and the pressure tool moves along the workpiece

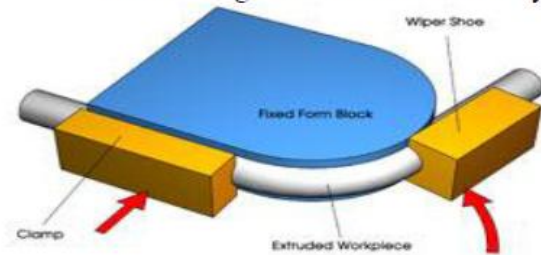

### Roll Forming

Involves the progressive bending of metal strip as it passes through a series of forming rolls  
Any material that can be bent can be roll- formed

### Seaming

- bending operation that can be used to join the ends of sheet metal to form containers such as cans, pails and drums

### Flanging

-the process of rolling on sheet metal in essentially the same manner as seaming

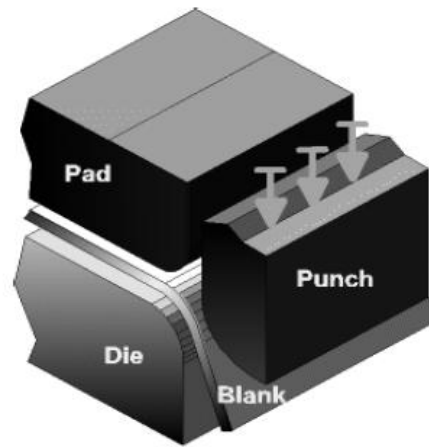
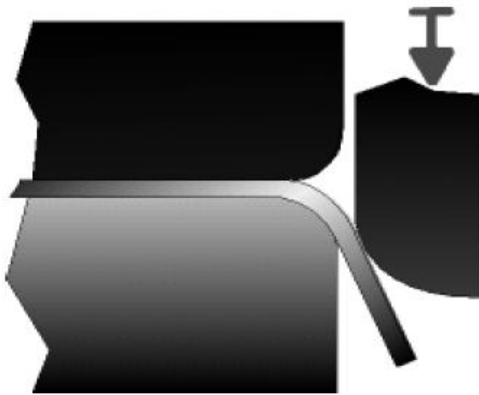

### Straightening

- also known as flattening
- opposite of bending

### Drawing- Stretch forming

Sheet metal clamped along its edges and stretched over a die or form block in required directions.

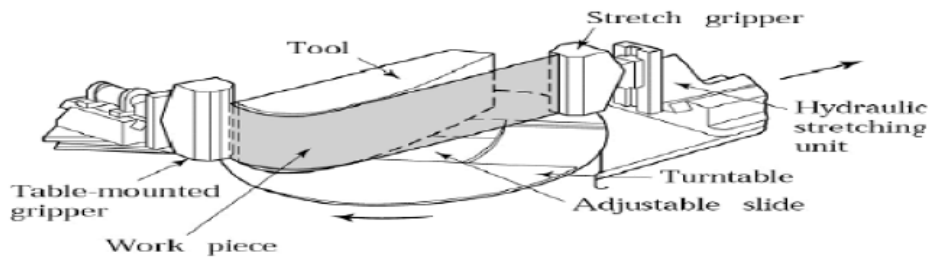

Fig: Schematic illustration of a stretch forming process. Aluminum skins for aircraft can be made by this process

### Special Forming Process

There are a great variety of sheet metal forming methods, mainly using shear and tensile forces in the operation.

- Progressive forming
- Rubber hydroforming
- Bending and contouring
- Spinning processes
- Explosive forming
- Shearing and blanking
- Stretch forming
- • Deep drawing

### Progressive forming

- Punches and dies are designed so that successive stages in the forming of the part are carried out in the same die on each stroke of the press.
- Progressive dies are also known as multi-stage dies.

### Rubber forming

In bending and embossing of sheet metal, the female die is replaced with rubber pad

### Hydro-form (or) fluid forming process

The pressure over rubber membrane is controlled throughout the forming cycle ,with max pressure up to 100 Mpi

As a result the friction at the punch-cup interface increases, this increase reduces the longitudinal tensile stresses in the cup and delays fracture

### Spinning

Shaping thin sheets by pressing them against a form with a blunt tool to force the material into a desired form

### Conventional spinning

A circular blank if flat or performed sheet metal hold against a mandrel and rotated ,while a rigid metal is held against a mandrel and rotated ,wile a rigid tool deforms and shapes the material over the mandrel.

### Shear Spinning

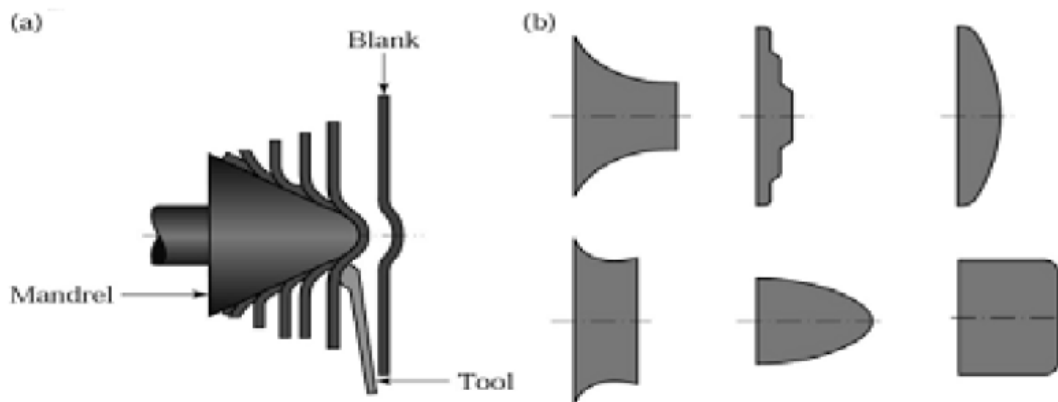
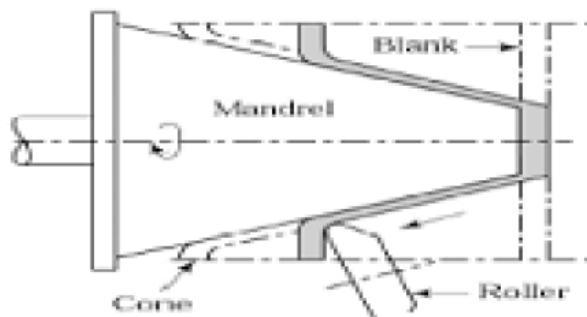

Fig .(a) Schematic illustration of the conventional spinning process (b) Types of parts conventionally spun.

All parts are antisymmetric

- Known as power spinning, flow turning, hydro-spinning, and spin forging
- Produces axisymmetric conical or curvilinear shape
- Single rollers and two rollers can be used
- It has less wastage of material
- Typical products are rocket-motor casing and missile nose cones.



### Tube spinning

Thickness of cylindrical parts are reduced by spinning them on a cylindrical mandrel rollers

Parts can be spun in either direction

Large tensile elongation up to 2000 % are obtained within certain temperature ranges and at low strain rates.

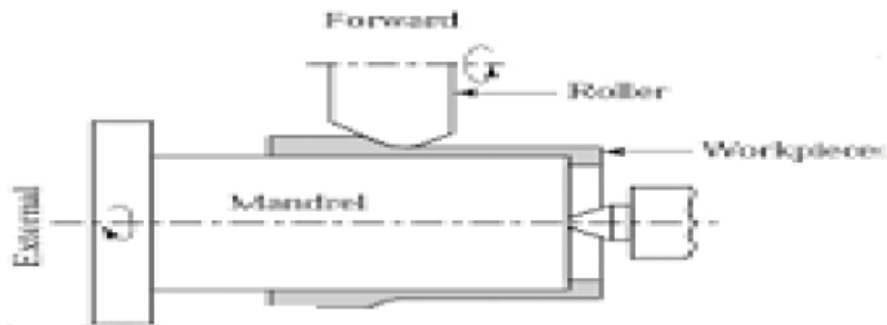

### Advantages

- Lower strength is required and less tooling costs
- Complex shapes with close tolerances can be made
- Weight and material savings
- Little or no residual stress occurs in the formed parts

### Disadvantages

- Materials must not be super elastic at service temperatures
- Longer cycle times

### Explosive forming

- Explosive energy used in metal forming
- Sheet-metal blank is clamped over a die
- Assembly is immersed in a tank with water
- Rapid conversion of explosive charge into gas generates a shock wave .the pressure of this wave is sufficient to form sheet metals

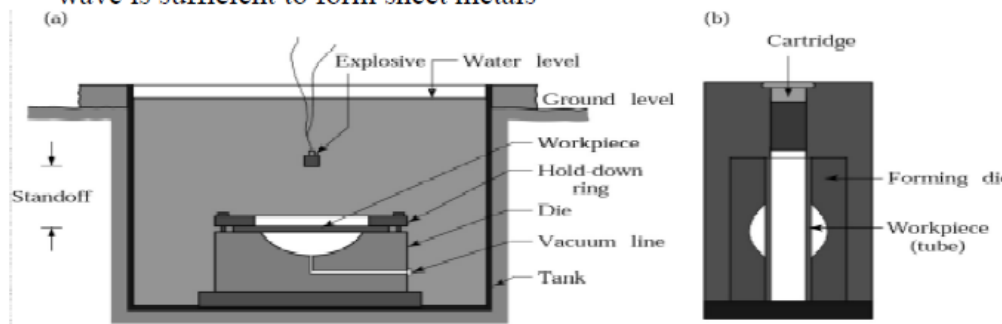

### Beading

The periphery of the sheet metal is bent into the cavity of a die



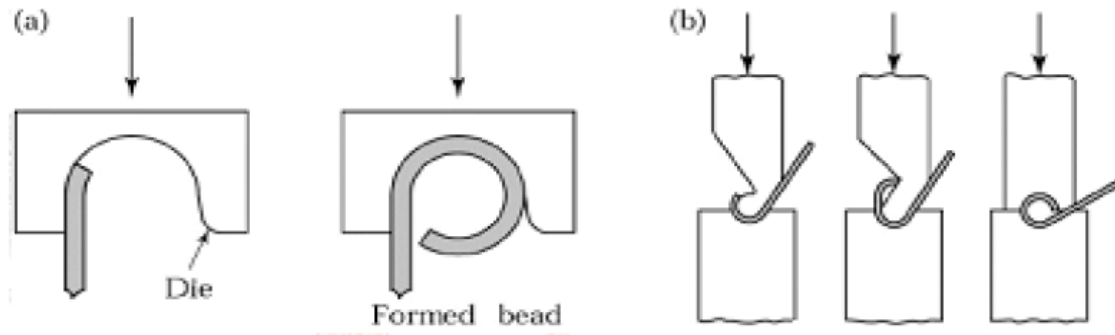

Fig .(a) Bead forming with a single die (b) Bead forming with two dies,in a press brake

### Hemming

- The edge of the sheet is folded over itself
- This increases stiffness of the part
- The metal strip is bent in stages by passing it through a series of rolls

### Seaming

Joining two edges of sheet metal by hemming. Specifically shaped rollers used for watertight and airtight joints

### Deep drawing

- Punch forces a flat sheet metal into a deep die cavity.
- Round sheet metal blank is placed over a circular die opening and held in a place with blank holder & punch forces down into the die cavity

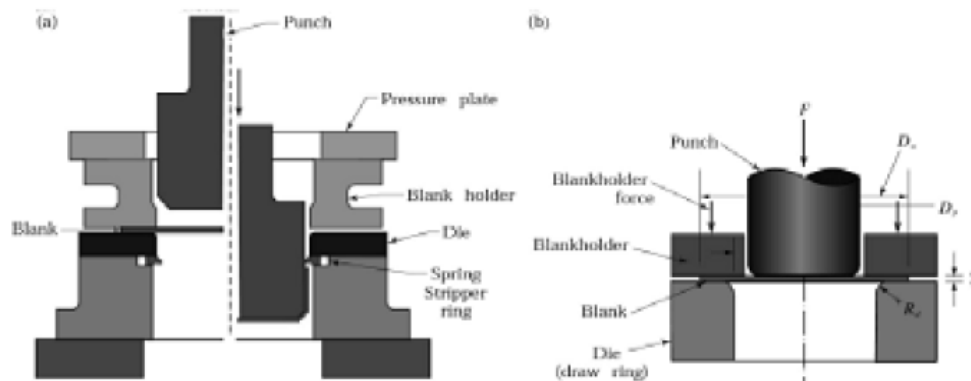

### Flanging

Flanging is a process of bending the edges of sheet metals to 90o

Shrink flanging – subjected to compressive hoop stress.

Stretch flanging –subjected to tensile stresses

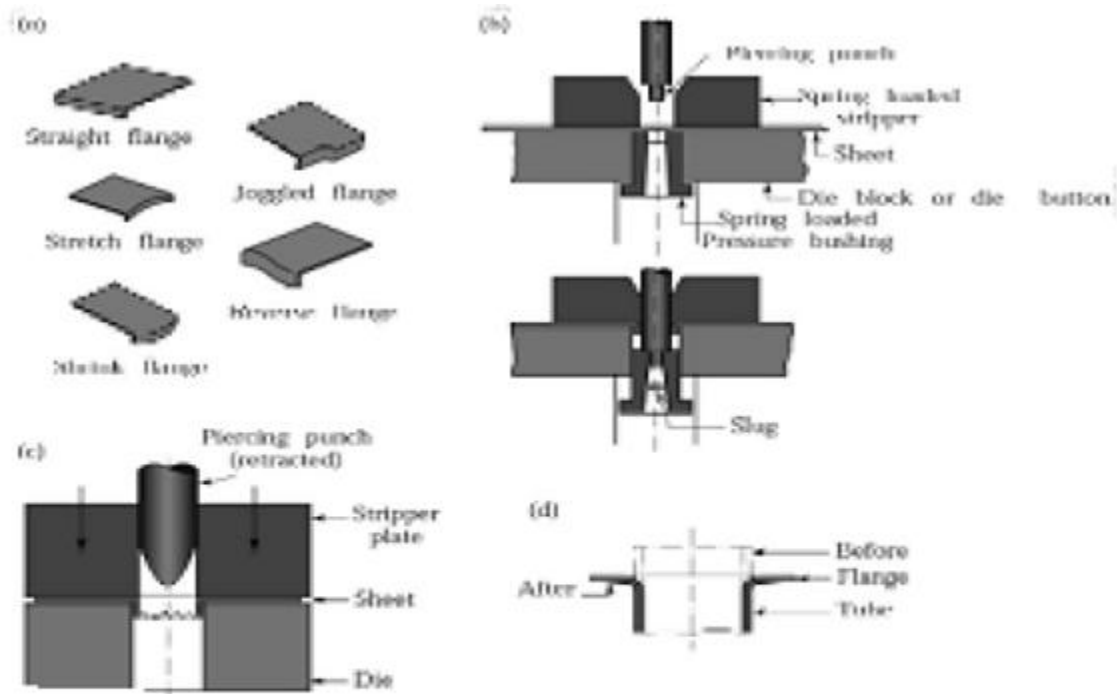

Fig. Various flanging operations (a) Flanges on a flat sheet. (b) Dimpling. (c) The piercing of the sheet metal to form a flange.

In this operation, a hole does not have to be prepunched before the punch descends. Note however, the rough edges along the circumference of the flange. (d) The flanging of a tube; note the thinning of the edges of the flange

## Common Polymers

### ABS (Acrylonitrile Butadiene Styrene)

Amorphous, good Impact Strength, excellent appearance, easy to process, computer housings, small appliances, automotive interior, & medical components

### Acrylic

Amorphous polymers, excellent clarity, excellent weatherability, optical & outdoor applications

### Cellulosics

Among the first thermoplastics developed: smell funny, very flammable

### Nylon

6

Semi-crystalline polymer, good cost to performance ratio, lower numbered nylons, absorb moisture and change their properties as a result

### Polycarbonate

Amorphous material, excellent Impact Strength, clarity, & optical properties

### Polyethylene

High

Density

widely used, inexpensive, thermoplastic, easy to process, good to excellent chemical resistance, soft & not for use above 150 F.

### Polypropylene

semi-crystalline material, low temperature material, excellent chemical resistance difficult to mold to extremely close tolerances

### Polystyrene

High

Impact

(HIPS)

few cents more than crystal styrene, to pay for the rubber modifier, opaque & very widely used, lower modulus, better elongation, & less brittle than crystal styrene

### PVC

Polyvinyl

Chloride

Rigid

properties similar to ABS (except appearance) at a slightly reduced cost primarily for water pipe and pipe fittings, occasionally for electrical enclosures \*in plastic phase PVC is corrosive to molds & machines (non corrosive as a solid)

# Characteristics of Forming and Shaping Processes for Plastics and Composite Materials

**TABLE 18.1**

Process	Characteristics
Extrusion	Long, uniform, solid or hollow complex cross-sections; high production rates; low tooling costs; wide tolerances.
Injection molding	Complex shapes of various sizes, eliminating assembly; high production rates; costly tooling; good dimensional accuracy.
Structural foam molding	Large parts with high stiffness-to-weight ratio; less expensive tooling than in injection molding; low production rates.
Blow molding	Hollow thin-walled parts of various sizes; high production rates and low cost for making containers.
Rotational molding	Large hollow shapes of relatively simple shape; low tooling cost; low production rates.
Thermoforming	Shallow or relatively deep cavities; low tooling costs; medium production rates.
Compression molding	Parts similar to impression-die forging; relatively inexpensive tooling; medium production rates.
Transfer molding	More complex parts than compression molding and higher production rates; some scrap loss; medium tooling cost.
Casting	Simple or intricate shapes made with flexible molds; low production rates.
Processing of composite materials	Long cycle times; tolerances and tooling cost depend on process.

## Plastics

Materials that can be reshaped (remolded) by applying heat and pressure. Most plastics are made from synthetic resins (polymers) through the industrial process of polymerization. Two main types of plastics are thermoplastics and thermosets.

### Two basic types of plastics

Thermoset- Heat hardening/ Undergoes chemical change

Thermoplastic- Heat softening/ Undergoes physical change

#### 1. Thermosets

General properties: more durable, harder, tough, light.

Typical uses: automobile parts, construction materials

#### Examples:

Unsaturated Polyesters: lacquers, varnishes, boat hulls, furniture

Epoxies and Resins: glues, coating of electrical circuits, composites: fiberglass in helicopter blades, boats, ...

#### 2. Elastomers

General properties: these are thermosets, and have rubber-like properties.

Typical uses: medical masks, gloves, rubber-substitutes

#### Examples:

Polyurethanes: mattress, cushion, insulation, toys

Silicones: surgical gloves, oxygen masks in medical applications joint seals

#### 3. Thermoplastics

General properties: low melting point, softer, flexible.

Typical uses: bottles, food wrappers, toys, ...

### Examples:

Polyethylene: packaging, electrical insulation, milk and water bottles, packaging film

Polypropylene: carpet fibers, automotive bumpers, microwave containers, prosthetics

Polyvinyl chloride (PVC): electrical cables cover, credit cards, car instrument panels

Polystyrene: disposable spoons, forks, Styrofoam™

Acrylics (PMMA: polymethyl methacrylate): paints, fake fur, plexiglass

Polyamide (nylon): textiles and fabrics, gears, bushing and washers, bearings

PET (polyethylene terephthalate): bottles for acidic foods like juices, food trays

PTFE (polytetrafluoroethylene): non-stick coating, Gore-Tex™ (raincoats), dental floss

### Advantages

Light Weight

High Strength-to-Weight Ratio

Complex Parts - Net Shape

Variety of Colors (or Clear)

Corrosion Resistant

Electrical Insulation

Thermal Insulation

High Damping Coefficient

“Low” pressures and temp required

### Disadvantages

Creep

Thermally Unstable- Can't withstand Extreme Heat

U-V Light Sensitive

Relatively low stiffness

Relatively low strength

Difficult to Repair/Rework

Difficult to Sort/Recycle

### Plastic Manufacturing Processes

A wide variety of plastic manufacturing processes exist

- Extrusion
- Lamination (Calendering)
- Thermal Forming
- Foaming
- Molding
- Expansion
- Solid-Phase Forming
- Casting
- Spinning

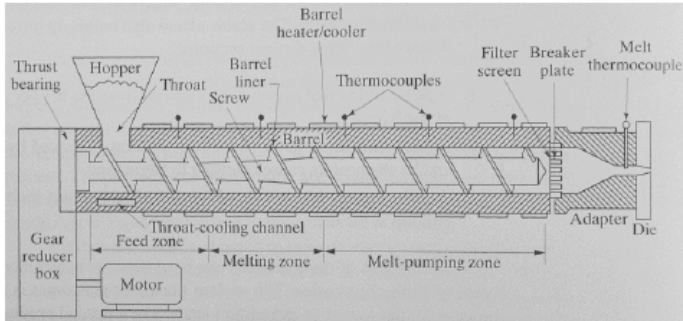

## Injection Molding

Most widely used process. Suitable for high production of thermoplastics. Charge fed from a hopper is heated in a barrel and forced under high pressure into a mold cavity. Several types. Variety of parts can be made.

### Basic components:

mold pieces (define the geometry of the part), and sprue, gates, runners, vents, ejection pins, cooling system

### Injection Molding: 2-piece and 3-piece molds

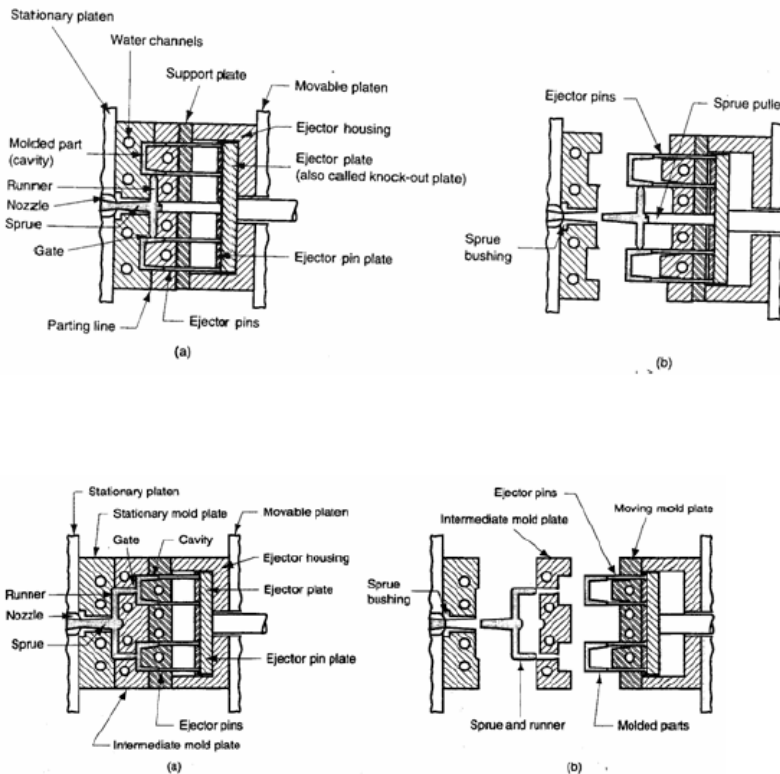

### Designing injection molds

1. molding directions --- number of inserts/cams required, if any
2. parting lines

3. parting planes --- by extending the parting line outwards
4. gating design --- where to locate the gate(s) ?
5. multiple cavity mold --- fix relative positions of the multiple parts
6. runners: flow of plastic into the cavity
7. sprue located:
8. functional parts of the mold
  - ejection system: to eject the molded part
  - systems to eject the solidified runners
  - alignment rods: to keep all mold components aligned

### Considerations in design of injection molded parts

The two biggest geometric concerns

- (i) proper flow of plastic to all parts of the mold cavity before solidification
- (ii) shrinking of the plastic resulting in sink holes

### Blow Molding

used to make thermoplastic bottles and hollow sections. Starting material is a round heated solid-bottom hollow tube – parison.

Parison inserted into two die halves and air is blown inside to complete the process

### General steps

- Melting the resin- done in extruder
- Form the molten resin into a cylinder or tube (this tube is called parison)
- The parison is placed inside a mold, and inflated so that the plastic is pushed outward against the cavity wall
- The part is allowed to cool in the mold and is then ejected
- The part is trimmed

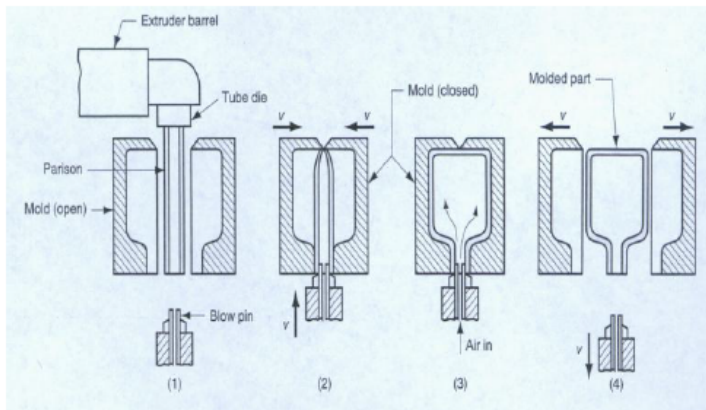

The parison can be formed by

- A) Extrusion process
- B) Injection molding process

### a) Extrusion blow molding

- Parison is formed from by forcing the plastic through an extrusion die.

- Material enters the die, flow around the mandrel so that extrudate would be cylindrical
- The die would have a hole at the center so that air could be blown into the cylinder
- In some blow molding operations, the air is introduced from the bottom through an inlet

This process can be;

- continuous extrusion blow molding
  - During the process, the extrusion runs continuously, thus making a continuous parison.
  - using multiple mold to match the mold cycle to the extrusion speed
- Intermittent extrusion blow molding
  - During the process, the extruder is stopped during the time that the molding occur
  - use either reciprocating screw or an accumulator system
- In this system, the output of the extruder is matched by having multiple molds which seal and blow the parison and then move away from extruder to cool and eject
- In practical case, the mold cycle is longer than time required to extrude a new parison
- If the mold cycle is twice than time needed for creating a parison, a two mold system can be used
- The method is sometimes called rising mold system - system of which two or more molds are used to mold parts from one extruder during continuous process

#### b) Injection Blow Molding

- The parison is formed by the injection of molten resin into a mold cavity and around a core pin
- The parison is not a finished product, but it is subjected to subsequent step to form the final shape
- Second step, blowing of the intermediate part in a second mold
- Because of distinct separation of the two steps, the parison made by injection molding is called a perform

#### Process

- The mold is closed
  - Resin is then injected to form a cylindrical part
  - The mold is opened and perform is ejected
- The perform can be stored until the finished blow molded is needed.

The flexibility of separating the two cycles has proven useful in manufacture of soda pop bottle.

#### Comparison of extrusion and injection blow molding

##### Extrusion blow molding

- It is best suited for bottle over 200g in weight, shorter runs and quick tool changeover
- Machine costs are comparable to injection blow molding
- Tooling costs are 50% to 75% less than injection machine



- It requires sprue and head trimming
- Total cycle is shorter than injection (since the parison and blowing can be done using the same machine)
- Wider choice of resin
- Final part design flexibility

### Injection blow molding

- Best suited for long runs and smaller bottles
- No trim scrap
- Higher accuracy in final part
- Uniform wall thickness
- Better transparencies with injection blow molding, because crystallization can be better controlled
- Can lead to improve mechanical properties from improved parison design.

### Common plastics for blow molding

- HDPE (stiff bottle, toys, cases, drum)
- LDPE (flexible bottle)
- PP (higher temperature bottle)
- PVC (clear bottle, oil resistant containers)
- PET (soda pop bottle)
- Nylon (automotive coolant bottle, power steering reservoir)

### Compression Molding

- The process of molding a material in a confined shape by applying pressure and usually heat.
  - Almost exclusively for thermoset materials
  - Used to produce mainly electrical products
- Thermoset granules are “compressed” in a heated mold to shape required.  
Examples: plugs, pot handles, dishware

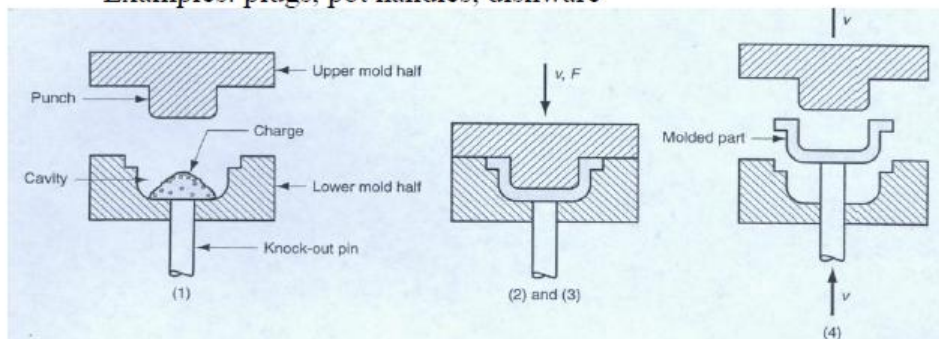

### Process

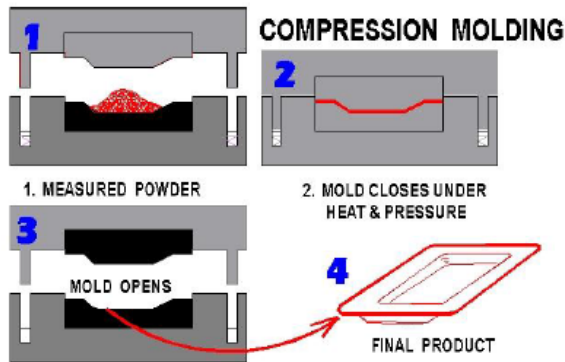

### Transfer Molding

- A process of forming articles by fusing a plastic material in a chamber then forcing the whole mass into a hot mold to solidify.
- Used to make products such as electrical wall receptacles and circuit breakers
- Similar to compression molding except thermosetting charge is forced into a heated mold cavity using a ram or plunger.

**Examples:** electrical switchgear, structural parts

### Process Variables

- Amount of charge
- Molding pressure
- Closing speed
- Mold temperature
- Charge temperature
- Cycle time

### Advantages

- Little waste (no gates, sprues, or runners in many molds)
- Lower tooling cost than injection molding
- Good surface finish
- Less damage to fibers
- Process may be automated or hand-operated
- Material flow is short, less chance of disturbing inserts, causing product stress, and/or eroding molds.

### Disadvantages

- High initial capital investment
- Labor intensive
- Secondary operations maybe required
- Long molding cycles may be needed.

### Cold Molding

Charge is pressed into shape while cold then cured in an oven. Economical but usually poor surface finish

### Extrusion

Extrusion is the process of squeezing metal in a closed cavity through a tool, known as a die using either a mechanical or hydraulic press. Similar to injection molding except long uniform sections are produced –e.g. pipes, rods, profiles.

Extrusion often minimizes the need for secondary machining, and as a result could result in financial savings. However extruded objects are not of the same dimensional accuracy or surface finish as machined parts.

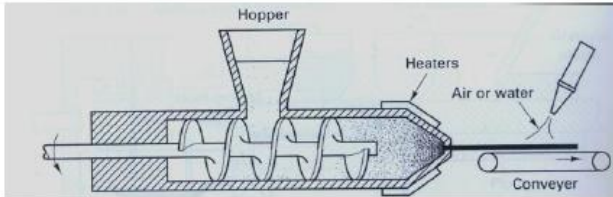

### Thermoforming

Sheet material heated to working temperature then formed into desired shape by vacuum suction or pressure. Suitable for large items such as bath tubs

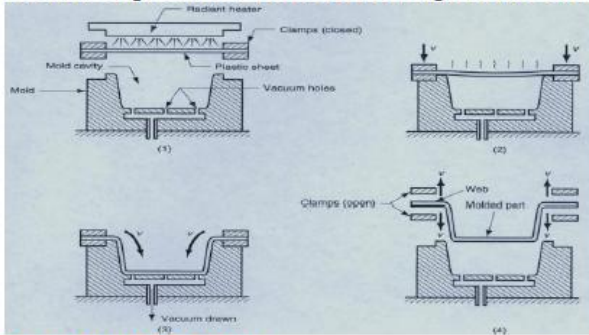

### Rotational Molding

Used to form hollow seamless products such as bins. Molten charge is rotated in a mold in two perpendicular axes simultaneously, or rotated while tilting.

### Foam Molding

Foaming agent is combined with the charge to release gas, or air is blown into mixture while forming.

Used to make foams. Amount of gas determines the density

### Calendaring:

Molten plastic forced between two counter-rotating rolls to produce very thin sheets e.g. polyethylene sheets

### Spinning

Modified form of extrusion in which very thin fibers or yarns are produced

### Machining

Material removal process such as drilling, turning, thread cutting. E.g. nylon fasteners. In general thermoplastics have poor machinability.

It is nothing more than Vacuum Forming with pressure assist to the forming process to enable crisper detail and sharper features. Pressure Forming utilizes pressurized air to push the heated sheet into the cavity. Pressure formed parts can resemble the detail of injection molded parts at a fraction of the tooling cost.

### **Vacuum Forming**

It is accomplished by heating the plastic sheet until it is pliable enough to be vacuumed either into a female mold or over a male mold.